



PDHonline Course M423 (6 PDH)

Photovoltaic Fundamentals

Instructor: Harlan H. Bengtson, Ph.D., PE

2020

PDH Online | PDH Center

5272 Meadow Estates Drive
Fairfax, VA 22030-6658
Phone: 703-988-0088
www.PDHonline.com

An Approved Continuing Education Provider

Acknowledgements

Authors: Gary Cook, Lynn Billman, and Rick Adcock

Typography, Design, and Artwork: Susan Szczepanski

Cover Design: Susan Szczepanski and Ray David

Editing: Paula Pitchford, James Jones, and Barbara Glenn

Technical Advisors and Reviewers: Michael Thomas, Sandia National Laboratories and Ken Zweibel, Solar Energy Research Institute.

This publication was produced under the Solar Technical Information Program at the Solar Energy Research Institute (SERI) for the U.S. Department of Energy (DOE).

We give special thanks to Vincent Rice and Robert Annan of the DOE for their support of the project and for their advice and review.

Photovoltaic FUNDAMENTALS

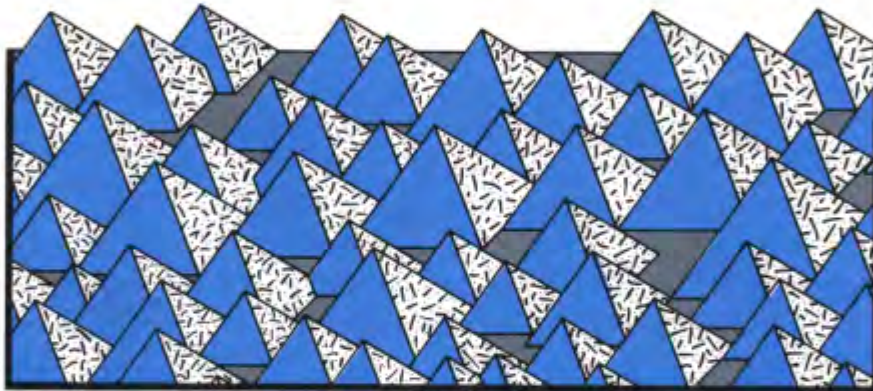

Contents

Introduction	1
1 An Overview of Progress	2
A Growing Market	4
A Promising Future	6
2 The Photovoltaic Effect	8
Energy from the Sun	8
An Atomic Description of Silicon	10
Light Absorption: Creating Charge Carriers	12
Forming the Electric Field	12
The Electric Field in Action: Driving the Charge Carriers	15
Energy Band Gaps	16
3 Solar Cells	18
Single-Crystal Silicon Cells	18
Beyond Single-Crystal Silicon—A Wide Range of Materials	24
Semicrystalline and Polycrystalline Silicon Cells	25
Thin-Film Solar Cells	27
Gallium Arsenide Solar Cells	36
Multijunction Devices	39
4 Modules, Arrays, and Systems	44
Flat-Plate Collectors	45
Concentrator Collectors	50
Balance of Systems	56
For Further Reading	62

Introduction

Photovoltaic (PV) systems convert sunlight into electricity. Once an exotic technology used almost exclusively on satellites in space, photovoltaics has come down to Earth to find rapidly expanding energy markets. Many thousands of PV systems have been installed around the globe. For certain applications, such as remote communications, PV systems provide the most cost-effective source of electric power possible.

Several important characteristics of PV systems make them a desirable source of power:

- They rely on sunlight.
- They generate electricity with little impact on the environment.
- They have no moving parts to wear out.
- They are modular, which means they can be matched to a need for power at any scale.
- They can be used as independent power sources, or in combination with other sources.

- They are reliable and long-lived.
- They use solid-state technology and are easily mass-produced and installed.

Photovoltaic devices can be made from many different materials in many different designs. The diversity of PV materials and their different characteristics and potentials demonstrate the richness of this growing technology.

This booklet describes how PV devices and systems work. It also describes the specific materials and devices that are most widely used commercially as of 1990 and those that have the brightest prospects. Students, engineers, scientists, and others needing an introduction to basic PV technology, and manufacturers and consumers who want more information about PV systems should find this booklet helpful.

We begin with an overview and then explain the rudimentary physical

process of the technology, the photovoltaic effect. Next, we consider how scientists and engineers have harnessed this process to generate electricity in silicon solar cells, thin-film devices, and high-efficiency cells. We then look at how these devices are incorporated into modules, arrays, and power-producing systems.

We have written and designed this book so that the reader may approach the subject on three different levels. First, for the person who is in a hurry or needs a very cursory overview, in the margins of each page we generalize the important points of that page. Second, for a somewhat deeper understanding, we have provided ample illustrations, photographs, and captions. And third, for a thorough introduction to the subject, the reader can resort to reading the text.

Chapter 1

An Overview of Progress

- The photovoltaic effect was discovered in 1839.
- Bell Laboratories scientists developed the first viable PV cells in 1954.

French physicist Edmond Becquerel first described the photovoltaic effect in 1839, but it remained a curiosity of science for the next three-quarters of a century. Becquerel found that certain materials would produce small amounts of electric current when

exposed to light. The effect was first studied in solids, such as selenium, by Heinrich Hertz in the 1870s. Soon afterward, selenium photovoltaic (PV) cells were converting light to electricity at 1% to 2% efficiency. (The conversion efficiency of a PV cell is the proportion of

sunlight energy that a cell converts to electrical energy.) Selenium was quickly adopted in the emerging field of photography for use in light-measuring devices.

Major steps toward commercializing PV were taken in the 1940s and early 1950s when the Czochralski process for producing highly pure crystalline silicon was developed. In 1954, scientists at Bell Laboratories depended on the Czochralski process to develop the first crystalline silicon photovoltaic (or solar) cell, which had an efficiency of 4%.

Although a few attempts were made in the 1950s to use silicon cells in commercial products, it was the new space program that gave the technology its first major application. In 1958, the U.S. Vanguard space satellite carried a small array of PV cells to power its radio. The cells worked so well that PV technology has

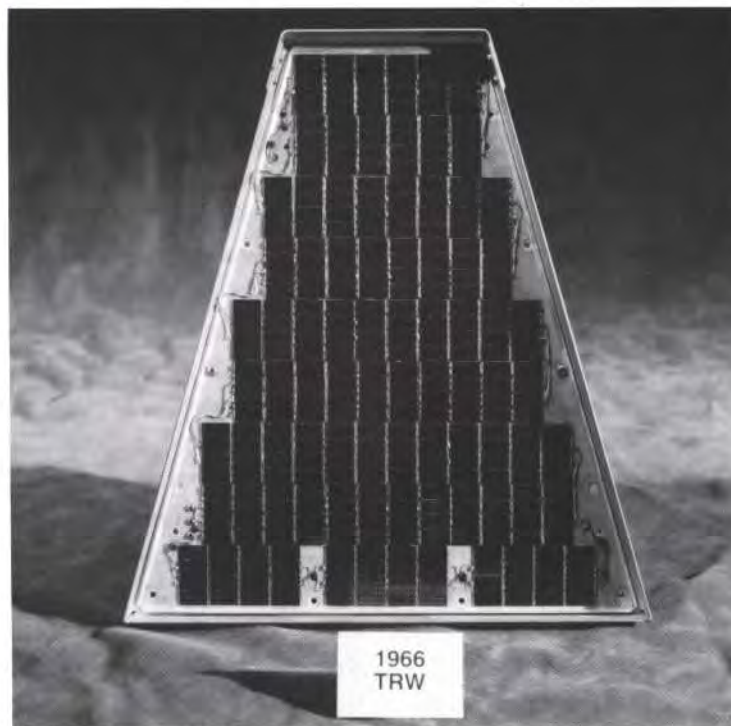

This photovoltaic module was developed in 1966 by TRW for use on a space mission.



Shortly after the development of silicon solar cells, ads like this touted photovoltaics as a new and promising source of electricity. But the development of affordable PV cells for use on Earth had to wait for the start of the federal/industry R&D program, some 20 years later. (Poster reproduction courtesy of Bell Laboratories and ARCO Solar News.)

been part of the space program ever since. Today, solar cells power virtually all satellites, including those used for communications, defense, and scientific research. The U.S. space shuttle fleet uses PV arrays to generate much of its electrical power.

The computer industry, especially transistor semiconductor technology, also contributed to the development of PV cells. Transistors and PV cells are made from similar materials and operate on the basis of similar physical mechanisms. Advances in transistor research have provided a steady flow of new information about PV cell technology. Today, however, this technology transfer process often works in reverse, as advances in PV research and development are sometimes adopted by the semiconductor industry.

Despite these advances, photovoltaics in 1970 was still too expensive for most terrestrial uses. In the

mid-1970s, rising energy costs, sparked by a world oil crisis, renewed interest in making PV technology more affordable. Since then, the federal government, industry, and research organizations have invested hundreds of millions of dollars in research, development,

and production. Often, industry and the federal government work together, sharing the cost of PV research and development (R&D).

Much of this effort has gone into the development of crystalline silicon, the material Bell's scientists used to make the first



Photovoltaic cells were first used in space to power a 5-mW backup transmitter on the Vanguard 1 in 1958. Today, solar cells power most satellites; even the U.S. shuttle fleet uses PV to generate much of its electrical power. (Rendition courtesy of Lockheed.)

- In the 1950s, the space program ushered in PV's first application. Solar cells power virtually all of today's satellites.
- Despite advances, in the early 1970s PV was still too expensive for terrestrial use.
- The energy crises of the 1970s sparked a major effort by the government and industry to make PV more affordable.

- Today's PV systems are efficient and reliable; they generate electricity for as little as 25¢/kWh.
- Technical advances have helped the annual PV market grow from a few thousand watts in the 1970s to nearly 47 million watts today.

practical cells. As a result, crystalline silicon devices have become more and more efficient, reliable, and durable. Industry and government have also explored a number of other promising materials, such as noncrystalline (amorphous) silicon, polycrystalline cadmium telluride and copper indium diselenide, and other single-crystal materials like gallium arsenide.

Today's commercial PV systems can convert from

5% to 15% of sunlight into electricity. They are highly reliable, and they last 20 years or longer. The cost of PV-generated electricity has dropped 15- to 20-fold, and PV modules now cost around \$6 per watt (W) and produce electricity for as little as 25¢ to 30¢ per kilowatt-hour (kWh).

A Growing Market

Price reductions have helped to spur a growing market for photovoltaics.

Shipments of PV modules have risen steadily over the last few years. In the last three years, worldwide module shipments have grown by 60% to nearly 47 million watts (MW). Revenues for the PV industry could be greater than \$800 million in 1991. Japan, European nations, China, India, and other countries have either established new PV programs or expanded existing ones. The number of organizations involved in

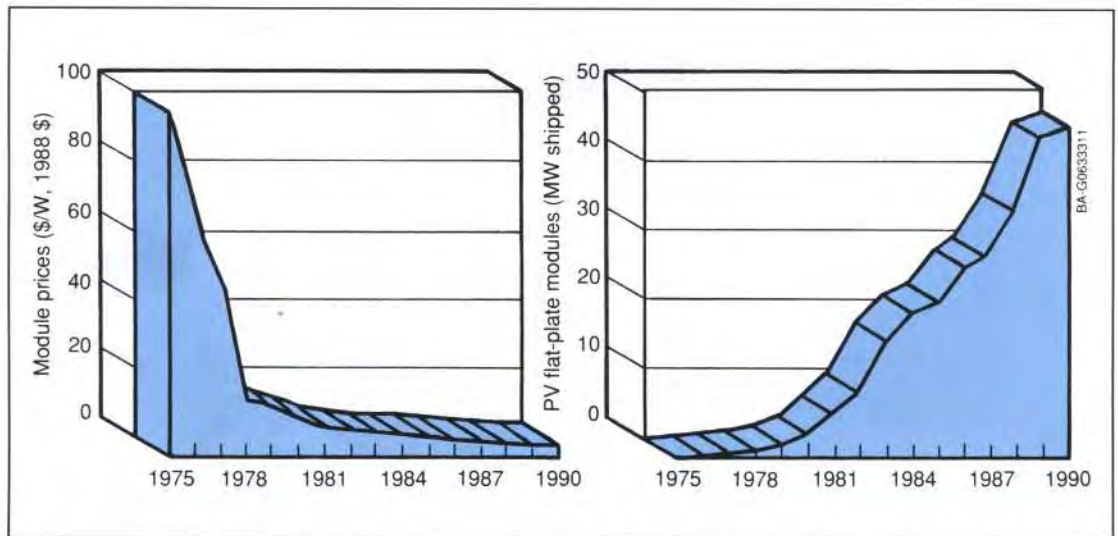

Since the United States started its terrestrial PV program in the mid-1970s, the cost of PV modules has dropped from more than \$100/W to less than \$6/W, and module shipments have risen from nearly zero to approximately 47 MW.

Photovoltaic cells power millions of small consumer products such as calculators, radios, watches, car window defrosters, and — as shown here — walk lights.

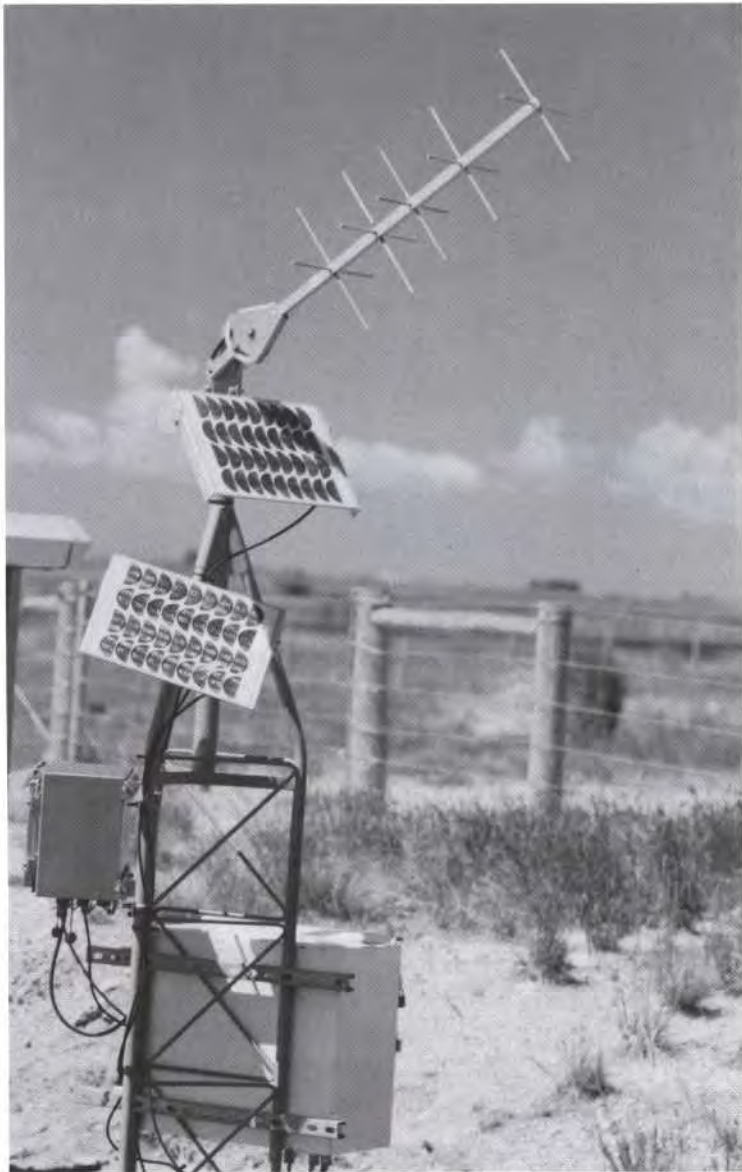

Mid-size PV systems (from a few watts to a few thousand watts) provide power for remote applications all over the world, including water pumping, refrigeration, highway lighting, and village power. Above, photovoltaics power a water-level-monitoring station on the Laramie River in Central Wyoming.

manufacturing and R&D grew from less than a dozen in the early 1970s to more than 200 in 1990.

The market is active in three principal areas: consumer products, stand-alone systems, and utility applications. Millions of small PV systems (producing from a few milliwatts, or a few thousandths of a watt, to a few watts) currently power watches, calculators, radios, portable TVs, walk lights, and a variety of other consumer goods. These systems are typically made with thin-film amorphous silicon material.

The largest of the photovoltaic markets is for mid-size, stand-alone systems, producing from a few watts of power to a few thousand watts. These are most often used to provide electricity in remote locations not served by a utility grid. Stand-alone PV systems are used in automated applications such as highway lighting, navigational buoys,

- Millions of consumer products, such as calculators and portable TVs, are powered by small PV systems.
- Mid-size, stand-alone PV systems are effective power sources, especially for remote applications.

- Tens of thousands of homes and cabins worldwide rely on PV systems for most or all of their electrical needs.
- Electric utilities are experimenting with large PV generating stations.
- As the cost of photovoltaics continues to decrease, through the avenues of R&D and mass production, the technology will become increasingly competitive for large-scale production of electricity for utilities.

lighthouses, microwave repeater stations, and weather stations. These stand-alone PV systems have proven to be reliable, maintenance-free, and cost-effective power sources. Also, tens of thousands of homes and cabins worldwide now rely on PV systems for most or all of their electrical needs. Solar electricity provides power for water pumps, for refrigerators that store vaccines and drugs, and for communications. PV systems have enormous potential to furnish electricity to towns and villages throughout the world that are not now connected to a utility grid.

PV is generally not yet competitive with most conventional sources for utility-size applications. However, several large PV systems (producing from a hundred thousand to several million watts) do provide supplemental power to electric utilities in the United States and a few other countries.



As the cost of photovoltaics continues to decrease, the technology becomes increasingly competitive for utilities. Above is a 2-MW single-axis-tracking photovoltaic system at Sacramento Municipal Utility District's Rancho Seco facility in Sacramento, California.

A Promising Future

To expand markets, PV costs need to be reduced further. There are two basic ways to reduce these costs. The first is through mass production, an avenue that the PV industry will follow as it continues to mature and grow. The second is

through research, development, and technology transfer, a path that both industry and the federal government are pursuing.

The federal government's R&D program is managed by the Department of Energy (DOE). The goals of the program are twofold. In the short term, through the



Mass production and advances in PV technology are crucial for PV systems to become competitive with conventional methods of generating electricity for utilities.

mid-1990s, the objective is to reduce the cost of PV electricity to about 12¢/kWh, which is the retail cost of electricity in many parts of the United States. The objective for the longer term, past the turn of the century, is to cut the cost of PV electricity in half again to about 6¢/kWh, which would make PV costs as low as those of most conventional sources of generated electricity.

Achieving these goals should help spur the market growth for

photovoltaics in all applications, from remote stand-alone systems to utility power plants. Photovoltaic systems are

already supplying a growing portion of America's demand for electricity. Photovoltaic systems are also increasingly becoming an option for the developing world, as the demand for electricity grows to serve the needs of burgeoning national economies and a human population that will double in the next century.

- The federal government aims to cut the cost of PV electricity to about 6¢/kWh.
- The PV market could grow dramatically by the turn of the century, supplying the world with as much as one billion watts of new electrical power per year.

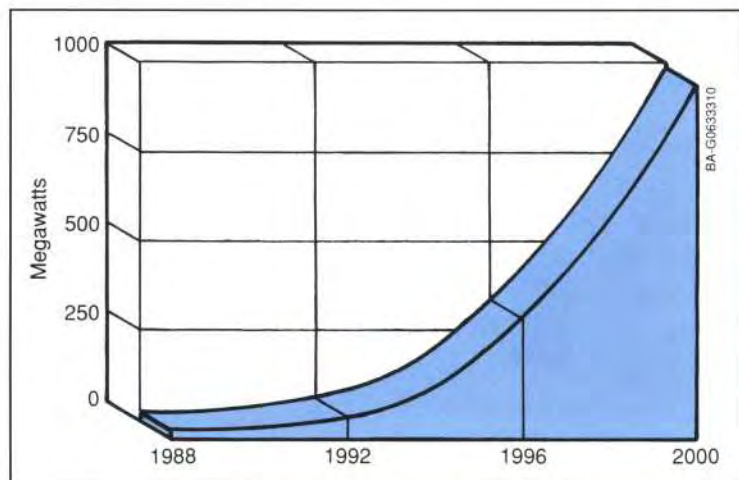

The world market for photovoltaic systems could increase dramatically by the end of this century.

Chapter 2

The Photovoltaic Effect

- In the PV effect, sunlight energy generates free electrons in a semiconductor device to produce electricity.
- The sun supplies all the energy that drives natural global systems and cycles.
- Each wavelength in the solar spectrum corresponds to a frequency and an energy; the shorter the wavelength, the higher the frequency and the greater the energy.

The photovoltaic effect is the basic physical process through which a PV cell converts sunlight into electricity. Sunlight is composed of photons—packets of solar energy. These photons contain different amounts of energy that correspond to the different wavelengths of the solar spectrum. When photons strike a PV cell, they may be reflected or absorbed, or they may pass right through. The absorbed photons generate electricity. The energy of

a photon is transferred to an electron in an atom of the semiconductor device. With its newfound energy, the electron is able to escape from its normal position associated with a single atom in the semiconductor to become part of the current in an electrical circuit. Special electrical properties of the PV cell—a built-in electric field—provide the voltage needed to drive the current through an external load.

Energy from the Sun

The sun's energy is vital to life on Earth. It determines the Earth's surface temperature, and supplies virtually all the energy that drives natural global systems and cycles. Although some other stars are enormous sources of energy in the form of x-rays and radio signals, our sun releases 95% of its energy as visible light. Visible light represents only a fraction of the total radiation spectrum; infrared and ultraviolet rays are also significant parts of the solar spectrum.

Each portion of the solar spectrum is associated with a different level of energy. Within the visible portion of the spectrum, red is at the low-energy end and violet is at the high-energy end (having half again as much energy as red light). In the invisible portions of the spectrum, photons in the ultraviolet region,

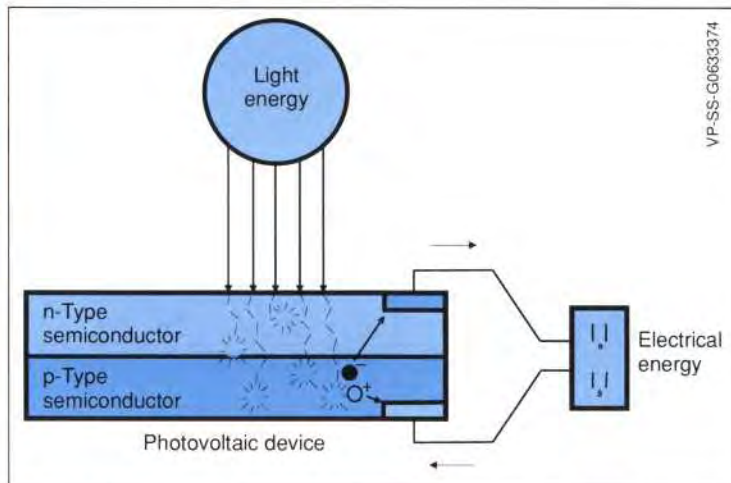

In the typical PV cell, photon energy frees electrical charge carriers, which become part of the current in an electrical circuit. A built-in electrical field provides the voltage needed to drive the current through an external load.

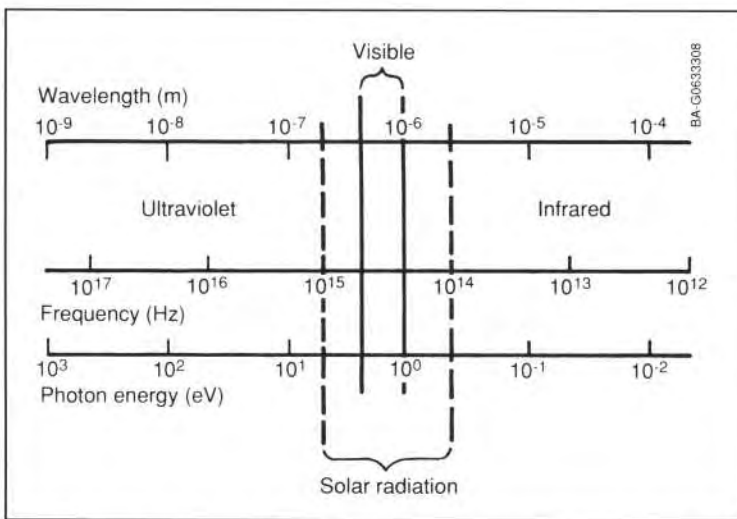

The sun emits virtually all of its radiation energy in a spectrum of wavelengths that range from about 2×10^{-7} to 4×10^{-6} m. The great majority of this energy is in the visible region. Each wavelength corresponds to a frequency and an energy; the shorter the wavelength, the higher the frequency and the greater the energy (expressed in eV, or electron volts; an eV is the energy an electron acquires when it passes through a potential of 1 V in a vacuum).

which cause the skin to tan, have more energy than those in the visible region. Photons in the infrared region, which we feel as heat, have less energy than the photons in the visible region.

The movement of light from one location to another can best be described as though it were a wave, and different types of radiation are characterized by their individual wavelengths. These wavelengths—the distance from the peak of one wave to the peak of the next—indicate radiation with different amounts of energy; the longer the wavelength, the less the energy. Red light, for example, has a longer wavelength and thus has less energy than violet light.

Each second, the sun releases an enormous amount of radiant energy into the solar system. The

Earth receives a tiny fraction of this energy; still, an average of 1367 W reaches each square meter (m^2) of the outer edge of the Earth's atmosphere. The atmosphere absorbs and reflects some of this radiation, including most

x-rays and ultraviolet rays. Yet, the amount of sunshine energy that hits the surface of the Earth every minute is greater than the total amount of energy that the world's human population consumes in a year.

When sunlight reaches Earth, it is distributed unevenly in different regions. Not surprisingly, the areas

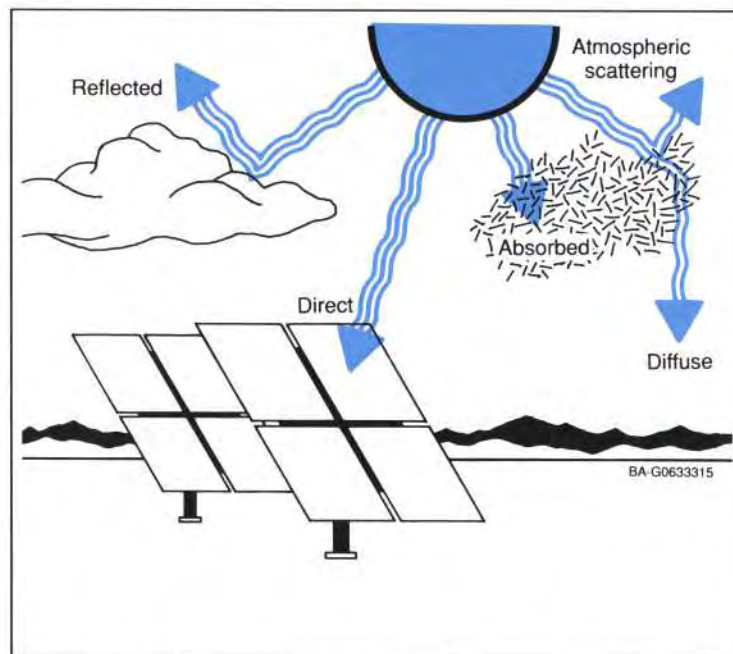

The Earth's atmosphere and cloud cover absorb, reflect, and scatter some of the solar radiation entering the atmosphere. Nonetheless, enormous amounts of direct and diffuse sunshine energy reach the Earth's surface and can be used to produce photovoltaic electricity.

- An average of 1367 W of solar energy strikes each square meter of the Earth's outer atmosphere.
- Although the atmosphere absorbs and reflects this radiation, a vast amount still reaches the Earth's surface.
- The amount of sunlight striking the Earth varies by region, season, time of day, climate, and measure of air pollution.

Although the quantity of solar radiation striking the Earth varies by region, season, time of day, climate, and air pollution, the yearly amount of energy striking almost any part of the Earth is vast. Shown is the yearly average radiation on a horizontal surface across the continental United States. Units are in kWh/m².

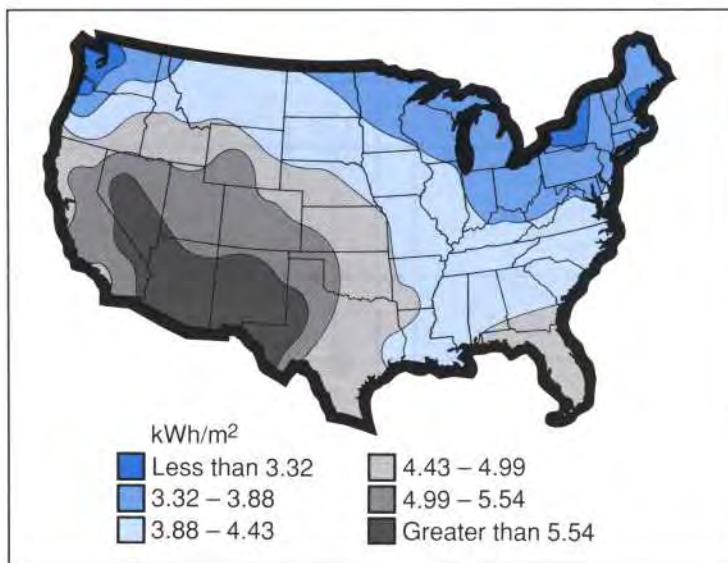

- The amount of electricity produced by a PV device depends on the incident sunlight and the device efficiency.
- Knowing how the PV effect works in crystalline silicon helps us understand how it works in all devices.
- All matter is composed of atoms.
- Positive protons and neutral neutrons comprise the nucleus of the atom.

near the equator receive more solar radiation than anywhere else on Earth. Sunlight varies with the seasons, as the rotational axis of the Earth shifts to lengthen and shorten days as the seasons change. The amount of solar energy falling per square meter on Yuma, Arizona, in June, for example, is typically about nine times greater than that falling on Caribou, Maine, in December. The quantity of sunlight reaching any region is also affected by the time of day, the climate (especially the cloud cover, which scatters the sun's rays), and the air pollution in that region. These climatic factors all affect the amount of solar energy that is available to PV systems.

The amount of energy produced by a PV device depends not only on available solar energy but on how well the device, or solar cell, converts sunlight to useful electrical energy. This is called the

device or solar cell efficiency. It is defined as the amount of electricity produced divided by the sunlight energy striking the PV device. Scientists have concentrated their R&D efforts over the last several years on improving the efficiency of solar cells to make them more competitive with conventional power-generation technologies.

An Atomic Description of Silicon

We use crystalline silicon to explain the photovoltaic effect for several reasons. First, crystalline silicon was the semiconductor material used in the earliest successful PV device. Second, crystalline silicon is still the most widely used PV material. And third, although other PV materials and designs exploit the PV effect in slightly different ways, knowing how the effect works in crystalline silicon

gives us a basic understanding of how it works in all devices.

All matter is composed of atoms. Atoms, in turn, are composed of positively charged protons, negatively charged electrons, and neutral neutrons. The protons and neutrons, which are of approximately equal size, comprise the close-packed central nucleus of the atom, where almost all of the mass of

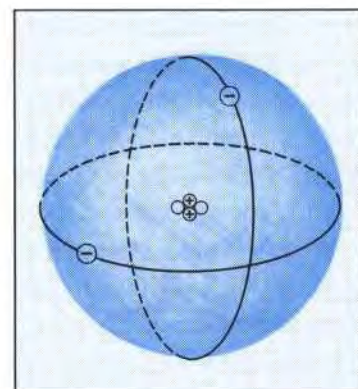

All matter is composed of atoms. Positive protons and neutral neutrons, making up the bulk of the weight of an atom, are tightly packed in the nucleus. Negative electrons revolve around the nucleus at different distances, depending on their energy level.

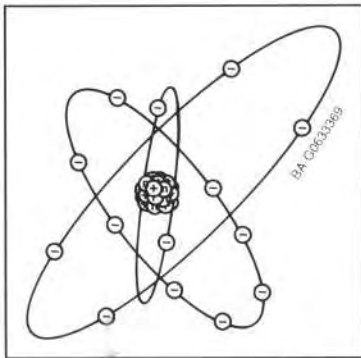

As depicted in this simplified diagram, silicon has 14 electrons. The four electrons that orbit the nucleus in the outermost, or valence, energy level are given to, accepted from, or shared with other atoms.

the atom is located. The much lighter electrons orbit the nucleus at very high velocities. Although the atom is built from oppositely charged particles, its overall charge is neutral because it contains an equal number of positive protons and negative electrons.

The electrons orbit the nucleus at different distances, depending on their energy level; an electron of lesser energy orbits close to the nucleus, while one of greater energy orbits farther away. The

electrons farthest from the nucleus interact with those of neighboring atoms to determine the way solid structures are formed.

The silicon atom has 14 electrons. Their natural orbital arrangement allows the outer four of these to be given to, accepted from, or shared with other atoms. These outer four electrons, called valence electrons, play

an important role in the photovoltaic effect.

Large numbers of silicon atoms, through their valence electrons, can bond together to form a crystal. In a crystalline solid, each silicon atom normally shares one of its four valence electrons in a covalent bond with each of four neighboring silicon atoms. The solid, then, consists of basic units of

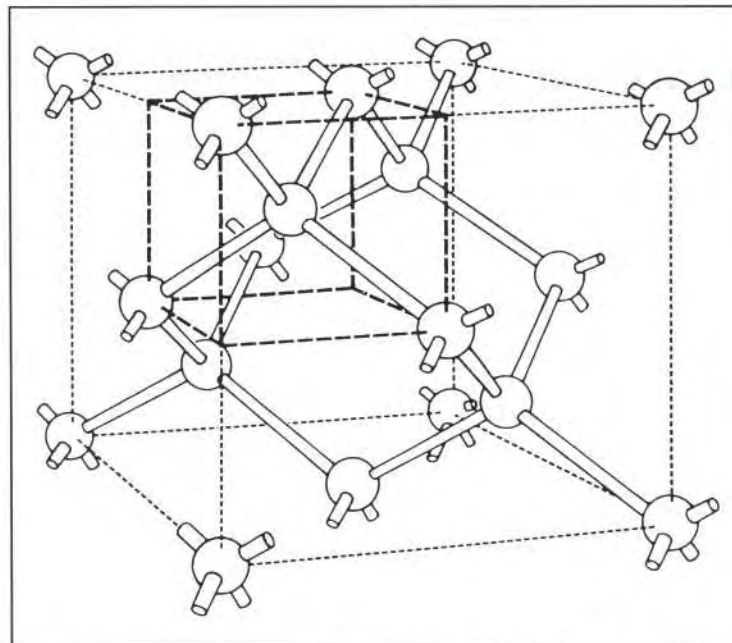

In the basic unit of a crystalline silicon solid, a silicon atom shares each of its four valence electrons with each of four neighboring atoms.

- Negative electrons orbit the nucleus at different distances, depending on their energy level.
- Outermost, or valence, electrons determine the way solid structures are formed.
- Four of silicon's 14 electrons are valence electrons.
- In a crystalline solid, a silicon atom shares each of its four valence electrons with each of four other silicon atoms.

Light of sufficient energy can dislodge a negative electron from its bond in the crystal, creating a positive hole (a bond missing an electron). These negative and positive charges, which move freely for a time about the crystal lattice, are the constituents of electricity.

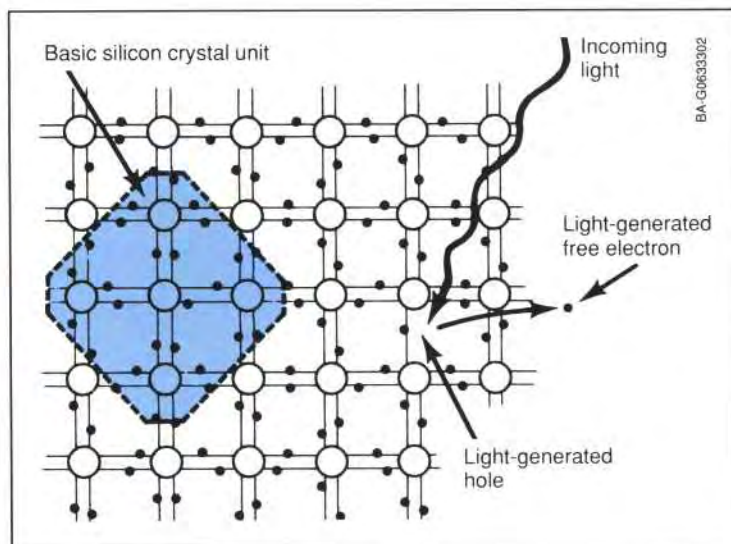

- Light of sufficient energy can dislodge an electron from its bond in the crystal, creating a hole.
- These negative and positive charges (free electrons and holes) are the constituents of electricity.
- PV cells contain an electric field that forces free negative and positive charges in opposite directions, driving an electric current.
- To form the electric field, the silicon crystal is doped (by introducing elements of another element) to alter the crystal's electrical properties.

five silicon atoms: the original atom plus the four other atoms with which it shares its valence electrons.

The solid silicon crystal is composed of a regular series of units of five silicon atoms. This regular, fixed arrangement of silicon atoms is known as the crystal lattice.

Light Absorption: Creating Charge Carriers

When a photon of sufficient energy strikes a valence electron, it may impart enough energy to free it from its connection to the atom. This leaves a space in the crystal structure where an electron once resided (and bonded), called a "hole." The electron is now free to travel about the crystal lattice. The electron is now a part of the conduction band, so called because these free electrons are the means by which the crystal conducts electricity.

Meanwhile, the atom left behind by the freed electron contains a net positive charge in the form of the generated hole. This positive hole can move almost as freely about the crystal lattice as a free electron in the conduction band, as electrons from neighboring atoms switch partners. These light-generated charges, both positive and negative, are the constituents of electricity.

Forming the Electric Field

Photovoltaic cells contain an electric field that is created when semiconductors with different electrical characteristics come into contact. The electric field drives positive and negative charges in opposite directions. The movement of charge carriers (through an external circuit) is what defines electricity.

There are several ways to form the electric field

in a crystalline silicon PV cell. The most common technique is to slightly modify the structure of the silicon crystal. This technique, known as "doping," introduces an atom of another element (called the "dopant") into the silicon crystal to alter its electrical properties. The dopant has either three or five valence electrons, as opposed to silicon's four.

Phosphorus atoms, which have five valence electrons, are used for doping n-type silicon (so called because of the presence of free negative charges or electrons). A phosphorus atom occupies the same place in the crystal lattice that was occupied formerly by the silicon atom it replaced. Four of its valence electrons take over the bonding responsibilities of the four silicon valence electrons that they replaced. But the fifth valence electron remains free, without bonding

Substituting a phosphorus atom (with five valence electrons) for a silicon atom in a silicon crystal leaves an extra, unbonded electron that is relatively free to move around the crystal.

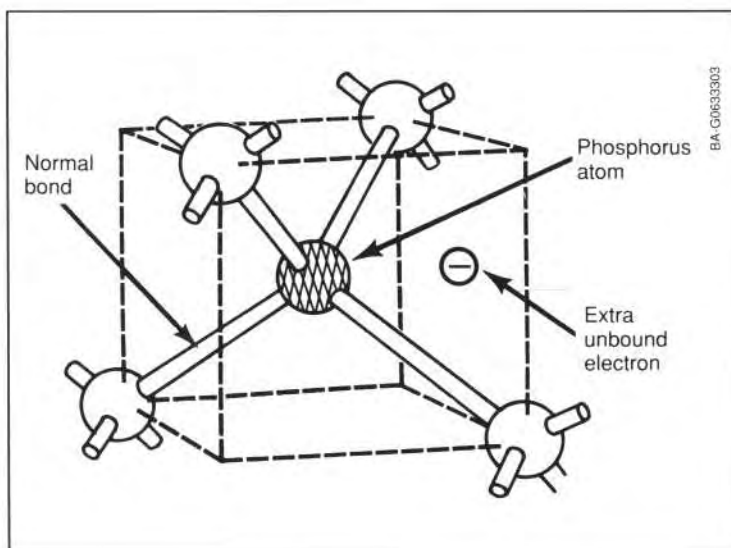

responsibilities. This unbonded valence electron behaves like a permanent member of the crystal's conduction band.

When numerous phosphorus atoms are substituted for silicon in a crystal, many free, conduction-band electrons become available. The most common method of substitution is to coat the top of a layer of silicon with phosphorus and then heat the surface. This allows the phosphorus

atoms to diffuse into the silicon. The temperature is then lowered so that the rate of diffusion drops to zero. Other methods of introducing phosphorus into silicon include gaseous diffusion, a liquid dopant spray-on process, and a technique in which phosphorus ions are driven precisely into the surface of the silicon.

This n-type silicon cannot form the electric field by itself; it is also necessary to have some silicon

atoms to diffuse into the silicon. The temperature is then lowered so that the rate of diffusion drops to zero. Other methods of introducing phosphorus into silicon include gaseous diffusion, a liquid dopant spray-on process, and a technique in which phosphorus ions are driven precisely into the surface of the silicon.

altered to have the opposite electrical properties. Boron, which has three valence electrons, is used for doping p-type (positive-type) silicon. Boron is introduced during silicon processing, where silicon is purified for use in PV devices (see Chapter 3). When a boron atom assumes a position in the crystal lattice formerly occupied by a silicon atom, there is a bond missing an electron—in other words, an extra hole. In p-type material, there are many more positive charges (holes) than free electrons.

Holes are much more numerous than free electrons in a p-type material and are therefore called the majority charge carriers. The few electrons in the conduction band of p-type material are referred to as minority charge carriers. In n-type material, electrons are the majority carriers, and holes are the minority carriers. Both p-type and

- Doping the crystal with phosphorus adds extra, unbonded electrons to the crystal, producing n-type material.
- Doping the crystal with boron leaves holes (bonds missing electrons, which act as positive charges) in the crystal, producing p-type material.
- In p-type material, holes, which are more numerous than free electrons, are the majority charge carriers.
- In n-type material, free electrons, which are more numerous than holes, are the majority charge carriers.

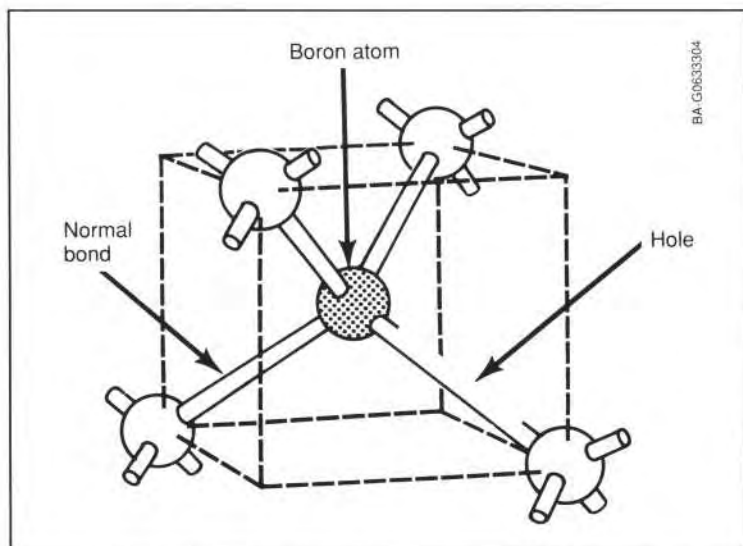

Substituting a boron atom (three valence electrons) for a silicon atom in a silicon crystal leaves a hole (a bond missing an electron) that is relatively free to move around the crystal.

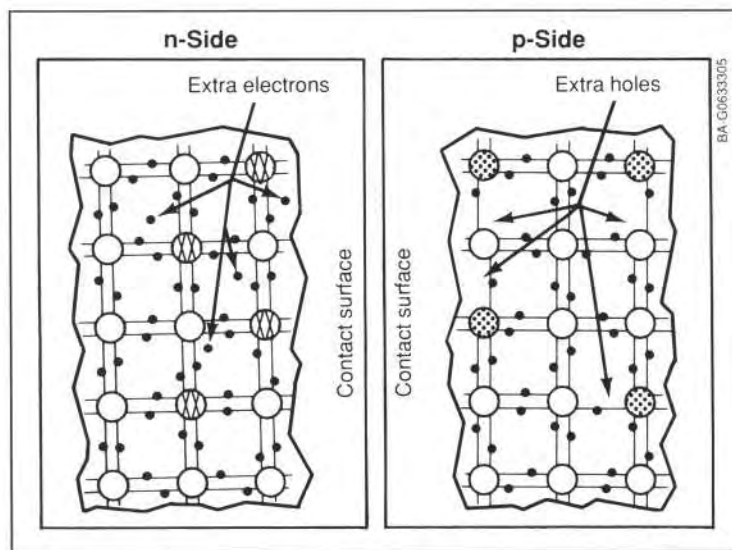

Although both materials are electrically neutral, n-type silicon has excess electrons and p-type silicon has excess holes.

- The majority carriers respond physically to an electric field.
- When n- and p-type material come in contact, an electric field forms at the junction (known as the p-n junction).
- Once the materials are in contact, the majority carriers diffuse across the junction.
- This creates (in the immediate vicinity of the junction) excess electrons on the p-side and excess holes on the n-side.

n-type silicon are by themselves electrically neutral; that is, each material contains an equal number of negatively charged electrons and positively charged protons.

The majority charge carriers, however, have excess energy that is not bound up in valence bonding with neighboring atoms. This higher energy allows them to traverse the crystal lattice. The majority carriers—electrons in n-type and holes in p-type silicon—are the ones that physically respond to an electric field. Electrons are attracted to and holes are repelled by an electric field.

When n-type and p-type silicon come into contact, an electric field forms at the junction (referred to as the p-n interface, or p-n junction). Like floodwaters breaking through a dam, some majority charge carriers on each side rush over to the other side. There are two forces at work in this

process. The majority charge carriers are more energetic and more mobile than the minority carriers. They are therefore able to move from where they are highly concentrated across the junction to a lower concentration. This is called diffusion. In addition, they are attracted (electrically) by the opposite charge of the majority carriers across the junction. In the immediate area of the junction, the “extra” electron

from the phosphorus fills the hole across the junction in the boron atom. Holes then overpopulate the immediate vicinity of the interface on the n-type side; electrons overpopulate the p-type side. This overabundance is true only in the immediate vicinity of the junction, however. The bulk of the n-type silicon is still populated with negative charges; holes remain the majority charge carriers

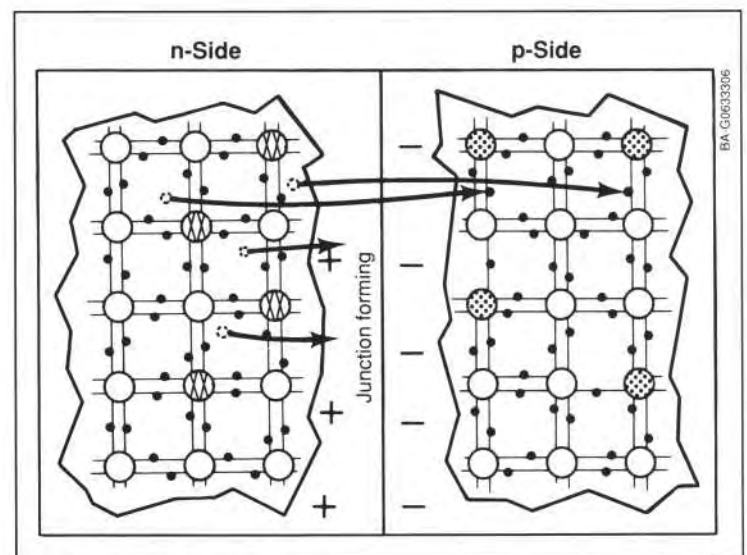

When n- and p-type silicon come into contact, electrons move from the n-side to the p-side. This causes a positive charge to build on the n-side of the interface (or p-n junction) and a negative charge to form on the other side.

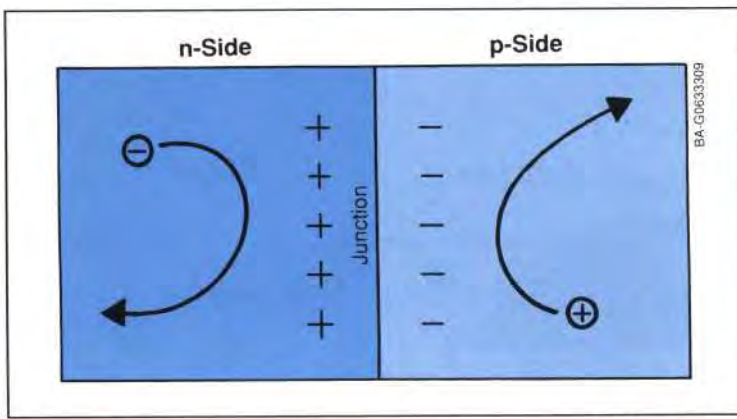

The buildup of excess positive and negative charges on either side of the junction creates an electric field across the interface; the strength of this field depends on the amount of dopant in the silicon. At equilibrium, the electric field repels any additional crossover of holes from the p-side or electrons from the n-side.

in the bulk of the p-type silicon.

At equilibrium, when all the charge carriers have settled down again, a net charge concentration exists on each side of the junction. This overpopulation of opposite charges creates an electric field across the interface. The strength of the electric force field depends upon the amount of dopant in the silicon—the more dopant we have, the greater will be the difference in electrical properties on each side and the greater the strength of the built-in electric field.

The Electric Field in Action: Driving the Charge Carriers

When a photon of light energy is absorbed by a silicon atom, an electron-hole pair is created, and both the electron and the hole begin moving through the material. If nature were left to take

its random course, they would recombine in about a millionth of a second and contribute nothing to an electrical current. But PV cells are so constructed that minority carriers have a good chance of reaching the electric field before recombining.

When a minority carrier (on either side of the junction) comes close enough to feel the force of the electric field, it is attracted to the interface; if the carrier has sufficient energy, it is propelled over to the other side. Majority

carriers, on the other hand, are repelled by this same electric field.

By acting this way, the field sorts out the photogenerated electrons and holes, pushing new electrons to one side of the barrier and new holes to the other. This sorting-out process is what gives the push to the charge carriers in an electrical circuit. Without the electric field, charge carriers generated by the absorption of light would go nowhere except back into the lattice.

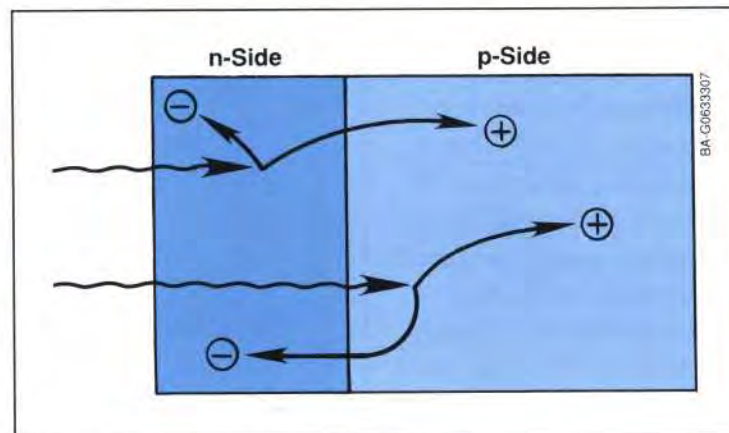

When sunlight striking a cell creates charge carriers, the electric field pushes new electrons to one side of the junction and new holes to the other. This sorting-out process is what drives the charge carriers in an electric circuit.

- At equilibrium there is a net concentration of opposite charges on either side of the junction, which creates an electric field across the junction.
- Photons absorbed by a cell create electron-hole pairs.
- The electric field attracts photogenerated minority carriers across the interface and repels photogenerated majority carriers.
- This sorting out of the photogenerated electrons and holes by the electric field is what drives the charge carriers in an electric circuit.

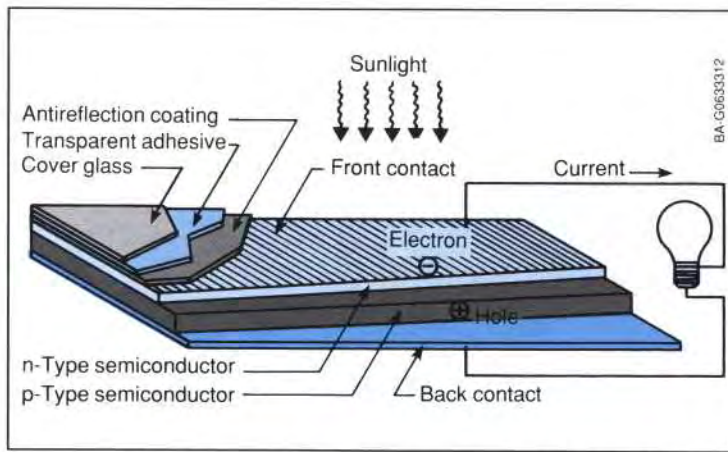

Attaching an external circuit allows the electrons to flow from the n-layer through the circuit and back to the p-layer where the electrons recombine with the holes to repeat the process.

- Attaching an external circuit allows electrons to flow from the n-layer through a load and back to the p-layer.
- The band-gap energy is the amount of energy required of a photon to move an electron from the valence band to the conduction band.
- Band-gap energies of PV materials range from about 1 to 3.3 eV; crystalline silicon's band-gap energy is 1.1 eV.

Attaching an external circuit allows the electrons to flow from the n-layer through the circuit and back to the p-layer, where the electrons combine with the holes to repeat the process. If there is no external circuit, the charge carriers collect at the ends of the cell. This buildup continues until equilibrium voltage (called the open-circuit voltage) is reached.

Energy Band Gaps

When photons of sunlight strike a PV cell, only the photons with a certain level of energy are able to free electrons from their atomic bonds to produce an electric current. This level of energy, known as the band-gap energy, is the amount of energy required to move an outer-shell electron from the valence band (or level) to the conduction band (or level). It is different for each material and for different

atomic structures of the same material.

For crystalline silicon, the band-gap energy is 1.1 electron-volts (eV). An electron-volt is equal to the energy an electron acquires when it passes through a potential of 1 volt in a vacuum. Other PV cell materials have band-gap energies ranging from 1 to 3.3 eV. The energy of individual photons in light is also measured in eV. Photons with different energies correspond to distinct wavelengths of light. The

entire spectrum of sunlight, from infrared to ultraviolet, covers a range of about 0.5 eV to about 2.9 eV. Red light has an energy of about 1.7 eV; blue light has an energy of about 2.7 eV.

One key to obtaining an efficient PV cell is to convert as much sunlight into electricity as possible. Choosing the best absorbing material is a very important step, because the band-gap energy of the material determines how much of the sun's spectrum can be absorbed.

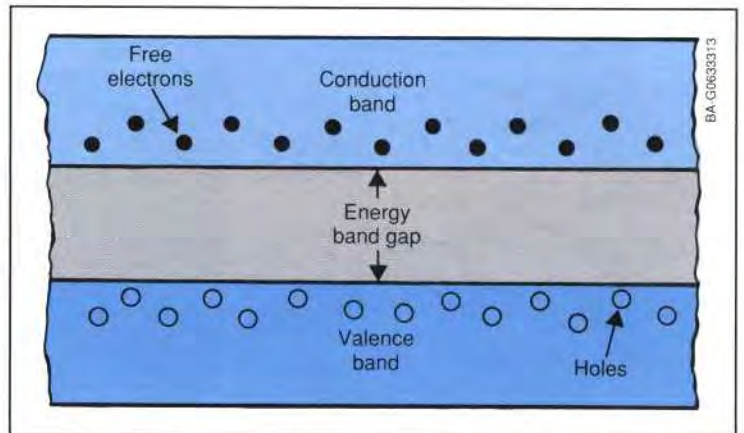

Photons with energies greater than the semiconductor material's band-gap energy are required to move electrons from the valence band to the conduction band and produce a current; crystalline silicon's band-gap energy is 1.1 eV.

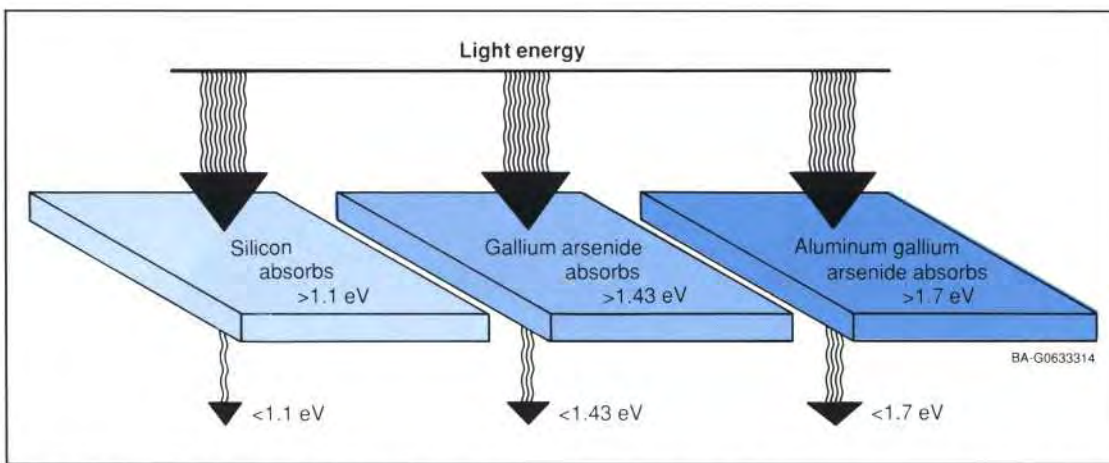

Different PV materials have different characteristic energy band gaps. Photons with energy greater than the band gap may be absorbed to create electron-hole pairs. Photons with energy less than the band gap pass through the material or create heat.

Silicon, for example, requires photons to have an energy of at least 1.1 eV to be absorbed and create pairs of charge carriers. Photons with less energy either pass right through the silicon or are absorbed as heat. Photons with too much energy are absorbed and contribute free charge carriers, but they also heat up the cell. About 55% of the energy of sunlight cannot be used by most PV cells because this energy either is below the band gap or carries excess energy. Researchers are working on advanced cell designs that can reduce those losses.

Materials with lower band-gap energies can exploit a broader range of the sun's spectrum of energies, creating greater numbers of charge carriers (greater current). We might conclude that material with the lowest band gap would thus make the best PV cell. But it isn't quite that simple. The band-gap energy also

influences the strength of the electric field, which determines the maximum voltage the cell can produce. The higher the band-gap energy of the material, the higher the open-circuit voltage.

The power from an electrical device such as a PV cell is equal to the product of the voltage (V) and the current (I). Low-band-gap cells have high current but low voltage; high-band-gap cells have high voltage and low current. A compromise is necessary in the design of PV cells. Cells made of materials with band gaps between 1 eV and 1.8 eV can be used efficiently in PV devices.

- Photons with too little energy pass through the material or create heat; photons with too much energy create charge carriers, but also heat up the cell.
- Materials with lower band-gap energies create greater currents; materials with higher band-gap energies have higher voltages.
- The electric power produced by a PV cell is $I \times V$, the product of the current and voltage.

Chapter 3

Solar Cells

- Single-crystal silicon is presently the most popular option for commercial cells.
- Silicon, the second most abundant element in the Earth's crust, occurs naturally as silicon dioxide in the form of sand or quartzite.
- High-grade quartzite is processed into highly pure silicon for PV cells.
- To begin the process, we first reduce quartzite to metallurgical-grade silicon, which is 98% to 99% pure silicon.

The cell is the smallest practical element that harnesses the photovoltaic effect to generate electricity. Although many semiconductor materials are available, single-crystal silicon is presently the most popular option for commercial cells. In this chapter we first explore how single-crystal silicon solar cells are made. We then take a look at several other important PV materials: polycrystalline silicon, amorphous silicon, copper indium diselenide, cadmium telluride, and gallium arsenide.

Single-Crystal Silicon Cells

Silicon is the second most abundant element in the Earth's crust (oxygen is the most abundant). Silicon occurs most often in nature as silicon dioxide (silica, SiO_2) and as silicates (compounds containing silicon, oxygen, metals, and maybe hydrogen). Sand and quartz are two of its most common forms. Sand is generally too impure to be processed into silicon, but high-grade deposits of quartzite can be almost 99% pure silica. This silica is processed

into the silicon that eventually becomes the basic material of a silicon solar cell.

Processing Silicon

To begin the process, we first reduce quartzite industrially to metallurgical-grade polycrystalline silicon (polysilicon), which is 98% to 99% pure silicon. Photovoltaic cells require polysilicon that is even purer, however, so further processing is required. At present, one of the highest-purity polysilicons is that used in semiconductor devices, referred to as semiconductor-grade

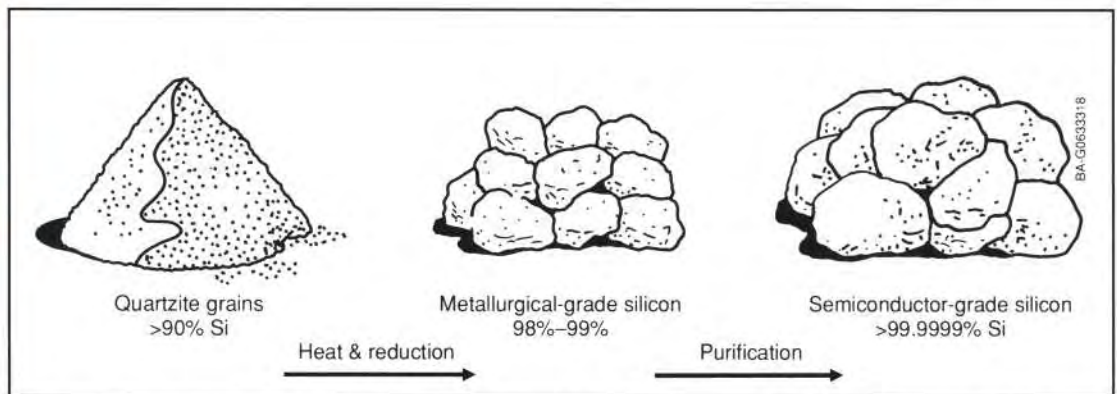

To get the pure silicon required for solar cells, grains of quartzite, which are 90% silicon, are heated and reduced to produce metallurgical-grade silicon, which is 98% to 99% pure. This material is then refined to produce semiconductor-grade silicon, a product that is at least 99.9999% pure silicon.

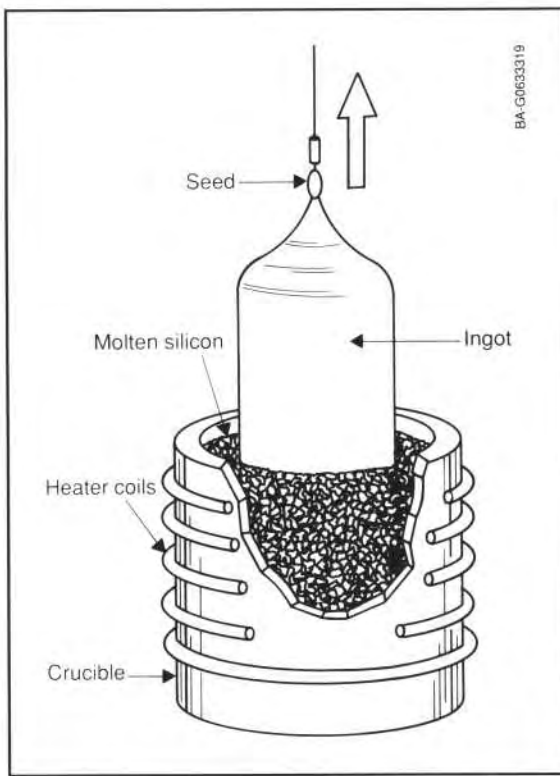

The most widely used technique for making single-crystal silicon is the Czochralski process, in which a seed of single-crystal silicon contacts the top of molten silicon. As the seed is slowly raised, atoms of the silicon melt solidify in the pattern of the seed and extend the single-crystal structure.

polysilicon. (Photovoltaic research has actually produced a more pure grade of polysilicon, but it is not yet in widespread use.)

To produce metallurgical-grade polysilicon, we heat the quartzite and add a controlled amount of carbon. This allows the oxygen to be removed as carbon dioxide. Additional processes are applied to remove more impurities. The result is a block or ingot of a medium-gray, metallic-looking substance that is metallurgical-grade polysilicon.

It is more expensive to convert this metallurgical-grade material to semiconductor-grade polysilicon than it is to produce the lower grade. Among other processes,

the metallurgical-grade polysilicon is converted to a family of chemicals called chlorosilanes. The chlorosilanes are purified in a process not unlike petroleum refining and then introduced into a chemical-reaction sequence that yields semiconductor-grade polysilicon.

There are some promising new methods for improving the economics of producing high-purity, semiconductor-grade silicon. The most successful has been a silane-based process that yields exceptionally consistent, high-quality polysilicon that is actually more pure than semiconductor-grade polysilicon.

Preparing Single-Crystal Silicon

To change it into the single-crystal state, we first melt the polysilicon. Then it reforms very slowly in contact with a single-crystal "seed." The polysilicon adapts to the pattern of the single-crystal seed as it cools and solidifies very gradually; a new ingot of single-crystal silicon is said to be "grown" out of the molten polysilicon. Several specific processes can be used to accomplish this. The most established and dependable means are the Czochralski (Cz) method and the floating-zone (FZ) technique.

In the Cz process, a seed crystal is dipped into a crucible of molten silicon and withdrawn slowly, pulling a cylindrical single crystal as the silicon crystallizes on the seed.

The FZ process produces purer crystals, because they are not contaminated

- We then refine metallurgical-grade silicon to produce semiconductor-grade silicon, which is 99.9999% pure silicon.
- To convert this highly pure silicon into single-crystal we generally use the Czochralski (Cz) or the float zone (FZ) method.
- In the Cz process, a seed crystal is dipped into a crucible of molten silicon and slowly withdrawn, pulling out a cylindrical single crystal.

- In the FZ process, a silicon rod is placed atop a seed crystal and lowered through electromagnetic coils, which heat and melt the silicon to form a single crystal.
- After growth, the cylindrical single crystals are sawed into thin wafers for processing into cells.
- We can avoid some of the expense of the Cz and FZ processes by growing flat crystalline sheets of silicon.

by the crucible as Cz crystals are. In the FZ process, a silicon rod is set atop a seed crystal and lowered through an electromagnetic coil. The coil's magnetic field induces an electric field in the rod, heating and melting the interface between the rod and the seed. Single-

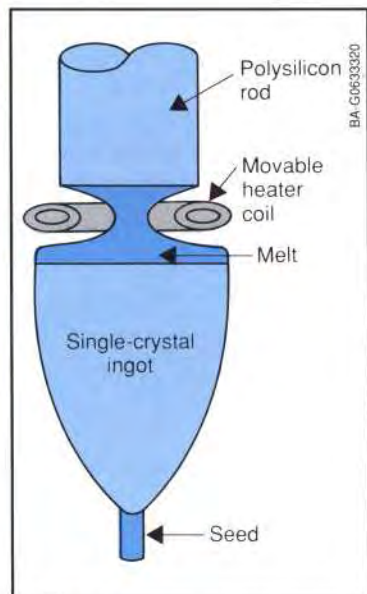

In the floating-zone technique, a silicon rod is set atop a seed crystal. Movable heating coils melt the interface between the seed and the silicon. Single-crystal material solidifies at the interface and moves upward as the heating coils are slowly raised.

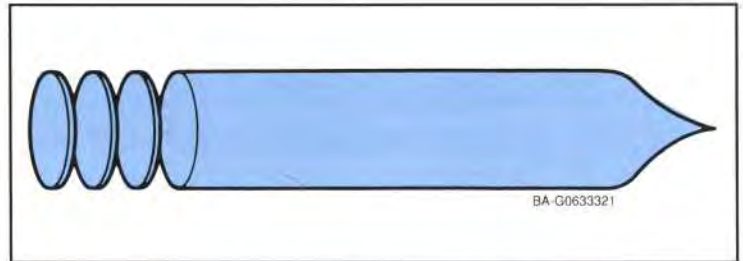

After the cylindrical ingot is grown it is sawed into thin wafers for further processing into PV cells. The sawing step wastes about 20% of the silicon as sawdust, or kerf.

crystal silicon forms at the interface, growing upward as the coils are slowly raised. In this floating-zone technique, the molten silicon is unsupported, maintaining itself through surface tension.

The next step is the same for both Cz and FZ ingots. The cylindrical single-crystal ingot is sawed into thin wafers for further processing into PV cells. The sawing step wastes 20% of valuable silicon as sawdust, known as kerf.

Although single-crystal silicon technology is well developed, the Cz, FZ, and ingot-casting processes are complex and expensive.

A group of new single-crystal-producing processes, however, generally called shaped-ribbon growth, could reduce processing costs by forming polysilicon directly into thin, usable wafers of single-crystal silicon. These methods involve forming thin crystalline sheets directly, thereby avoiding the sawing step required of cylindrical ingots.

Growing flat crystals in a dendritic web has also generated much interest. This technology involves withdrawing single-crystal, wirelike (dendritic) seeds from molten silicon. As the wirelike dendrites are

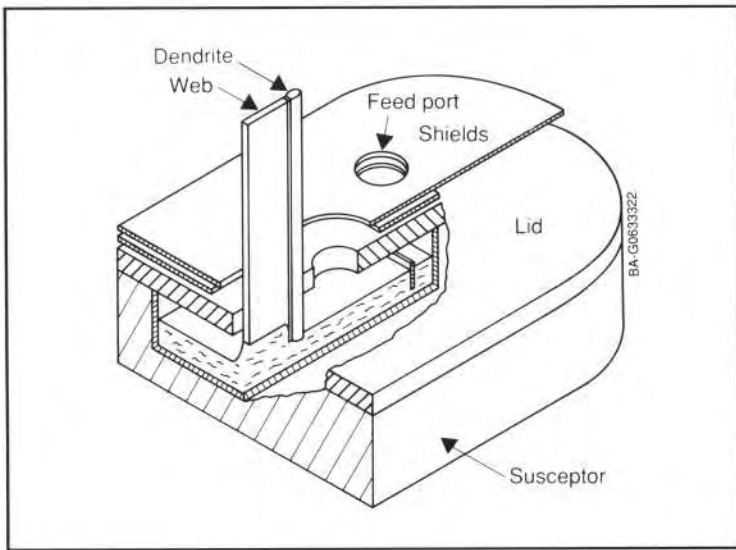

The dendritic web process uses twin, single-crystal dendritic seeds that are slowly drawn from molten silicon. As the dendrites are withdrawn, a web of single-crystal silicon forms between them, solidifying as it rises from the melt. (Half the film is shown.)

withdrawn, a web of single-crystal silicon forms between them, solidifying as it rises from the melt. The dendritic-web process produces high-quality cells that are more efficient than those from any other shaped-growth process.

Producing a Crystalline-Silicon Cell

After the single-crystal silicon wafer has been manufactured, the PV cell may be constructed. Although manufacturers use several different designs, there are some elements common to all PV cells. A typical single-crystal silicon PV cell consists of several layers: a conducting grid on the top surface; an antireflective coating or treated surface layer; a thin layer of silicon (usually n-type) about one millionth of a meter (a micrometer or micron) thick, which is called the collector; a very narrow electric field region at the

junction that enables a current to be produced; a silicon base layer (usually p-type), doped oppositely to the collector; and a back-contact electrode.

Adding Antireflection Coatings

Silicon is a shiny gray material. Left untreated, the surface of the PV cell can act like a mirror, reflecting more than 30%

of the light that strikes it. So the top surface through which light passes must be treated to minimize reflection.

Treating the top surface with a thin layer of silicon monoxide (SiO) greatly reduces reflection. A single layer of SiO reduces the surface reflection to about 10%. Adding an additional layer of another substance can reduce reflection to less than 4%; this is

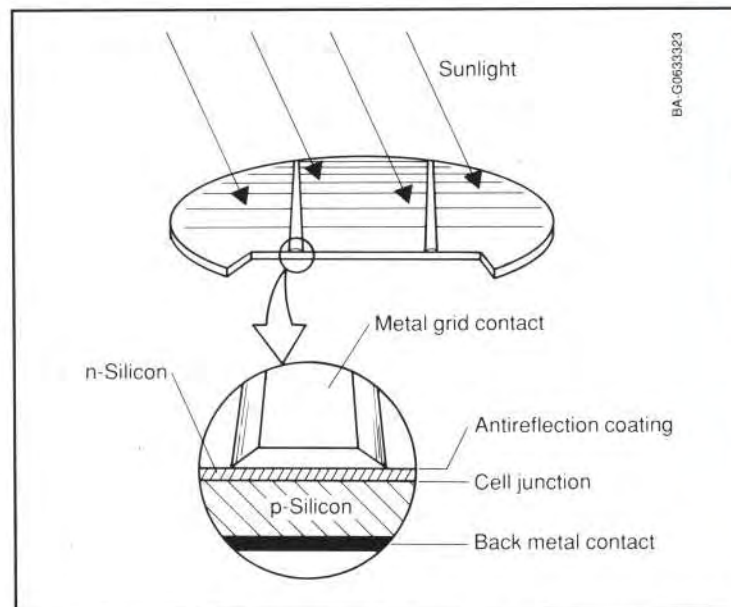

A typical single-crystal silicon cell consists of a top-surface grid, an antireflection coating, n-silicon, p-silicon, and a back metal contact.

- The dendritic web technique uses wirelike seeds to pull silicon from the melt; a web of single-crystal silicon forms between the seeds.
- After manufacturing the silicon wafer, we construct the PV cell.
- The typical cell consists of a grid, antireflection coating, n-silicon, p-silicon, and a back metal contact.
- The antireflection coating, made with layers of silicon monoxide, reduces reflection of light from the cell's top surface.

- Another way to reduce reflection is to texture the top surface of a cell.
- Combining texturing with antireflection coating can lower reflection to less than 2% of the incoming light.
- Electrical contacts attached to a PV cell collect the photogenerated charge carriers and allow the cell to become part of an electrical circuit.

referred to as a double-layer antireflection coating.

Another way to reduce reflection is to texture the top surface of a cell. Texturing causes reflected light to strike a second surface before it can escape, increasing the probability that the light will be absorbed. For example, light with an 80% probability of being absorbed by a flat

surface will have a 96% chance of being absorbed by a textured surface. Texturing has become routine on high-quality solar cells. Chemical etching creates texturing on the cell's surface. It makes a pattern of cones and pyramids, which capture light rays that might otherwise be deflected away from the PV cell, and

redirects them down into the cell.

The highest-efficiency cells typically use a well-designed, double-layer antireflection coating and a textured surface. This combination can lower reflection to less than 2% of the incoming light.

Attaching Electrical Contacts

Electrical contacts attached to a PV cell allow it to become part of an electrical circuit. The back contact of a cell (away from the sun) is relatively simple and usually consists of a layer of aluminum or molybdenum metal. The front contact (facing the sun) is more complicated. When placed in sunlight, the cell generates current (flowing electrons) all over its surface. Attaching contacts just at the edges of a cell would not be adequate because of the excessive electrical resistance of the top layer in this configuration. The contacts must be

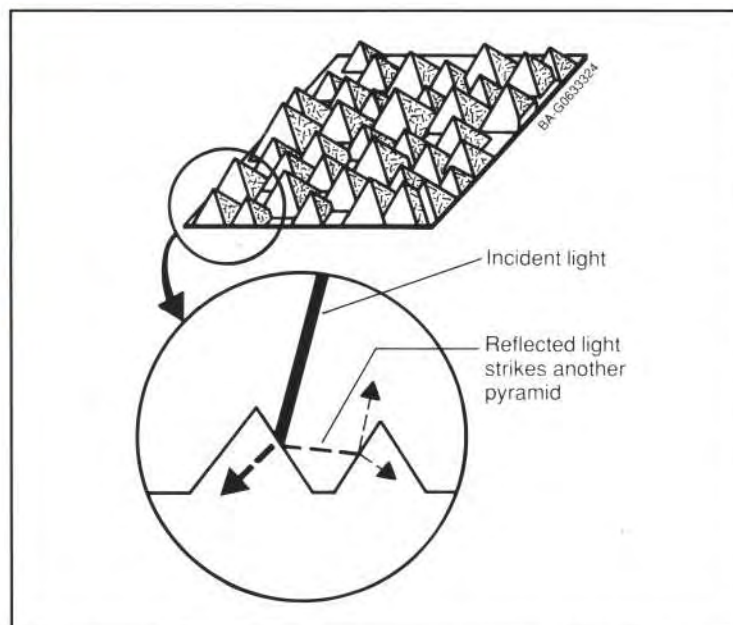

Texturing, which produces small pyramidal structures on a cell's top surface, increases the probability that light will be absorbed into the cell. Light that may otherwise be reflected will strike another surface, giving it another chance to be absorbed.

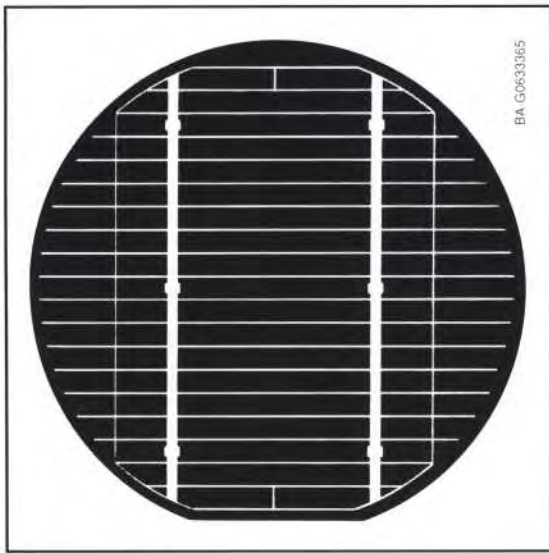

Contacts on the top surface of a typical cell are designed as grids, with many thin, conductive fingers spreading to every part of the cell's surface.

made across the entire surface to collect the most current. Large contact areas on the top of the cell, however, shade the active parts of the solar cell and reduce the cell's conversion efficiency.

Therefore, in designing electrical contacts, we must balance electrical resistance losses against shading effects. The usual approach is to design top-surface contacts as grids, with many thin, conductive fingers spreading to every part of the cell's surface. The fingers of the grid must be thick enough to conduct well (with low resistance), but thin enough to block a minimum of incoming light. Such a grid keeps resistance losses sufficiently low, while shading only about 3% to 5% of the surface.

Grids can be expensive to fabricate and can affect dependability. To make top-surface grids, we can

deposit metallic vapors on a cell through a mask or paint them on via a screen-printing method. For the highest quality (and greatest cost), photolithography is the preferred method. This is the transfer of an image via photography, as in modern printing. New cell designs, such as those for concentrated light, may require that light enter the cell from the back as well as the front, so that the

back of the cell would also need antireflection coatings and grid contacts. Researchers are examining alternative grid designs, including innovative ways of placing them only on the cell's back surface. They are also working on improvements for transparent conducting grid materials and on special grids and covers for concentrator cells (see Chapter 4).

- Contacts on the top surface are typically designed as grids, with fingers reaching to every part of the cell's surface.
- Grids are applied to the top surface in a number of ways, including screen printing and photolithography.

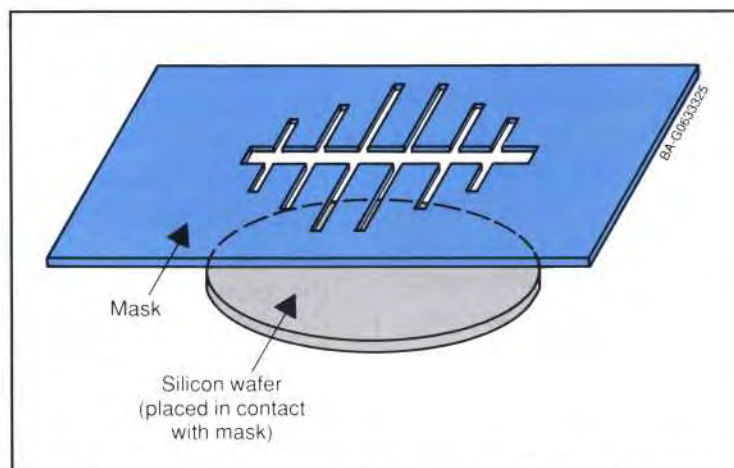

Grids are often deposited on the top surface of a cell through a mask that defines the grid pattern.

- Single-crystal silicon is just one of many semiconductor materials suitable for PV.
- Important characteristics of PV materials include electronic properties, absorptivity, band gap, and cost.
- Besides single-crystal silicon, today's most important PV materials include semicrystalline silicon, amorphous silicon, polycrystalline thin films, and gallium arsenide.

Beyond Single-Crystal Silicon—A Wide Range of Materials

Silicon is not the only material that will respond to sunlight by generating electron-hole pairs of charge carriers. Many semiconductors have similar properties. Furthermore, any two dissimilar semiconductor materials will form a junction and an electric field at their interface that could provide the voltage to drive a solar cell. There are a lot of choices to be made in making a PV device, both in material properties and device designs. The most important design parameters to consider are

- The material's electronic properties (especially its degree of crystallinity)
- The amount of light that can be absorbed in a given thickness of material (its absorptivity)

Characteristics of Commercially Ready and Nearly Ready Solar Cell Material Designs

	Electronic Material Properties	Absorptivity	Band Gap	Cost
Single-Junction Designs				
Single-crystal silicon	HI	LO	MED	HI
Polycrystalline silicon	MED	LO	MED	MED
Amorphous silicon	LO	HI	MED	LO
Polycrystalline thin films (CIS, CdTe)	MED	HI	MED to HI	LO
Single-crystal thin films (GaAs, InP)	HI	HI	HI	HI
Multijunction Designs	LO to HI	HI	HI	LO to HI

HI = High cost or excellent characteristics.
 MED = Medium cost or fair to good characteristics.
 LO = Low cost or relatively poor characteristics.

- The range of wavelengths in the sun's spectrum that can be absorbed and used (the band gap)
- The expected cost, because of the amount and type of material used and the complexity of the manufacturing process.

Single-crystal silicon has a high degree of crystallinity, which makes a high sunlight-to-electricity conversion efficiency relatively easy to attain. Its absorptivity is relatively low, however, which is why

older silicon cell designs required about 300 microns of material to absorb all the sunlight possible, and newer silicon cell designs still require about 100 microns of material. Silicon's band gap of 1.1 eV is workable but not ideal. Solar cells with the highest theoretical efficiencies employ materials with band gaps of 1.4 to 1.5 eV.

The wide variety of PV materials available makes trade-offs possible among design parameters. Out of the hundreds of different materials and cell designs

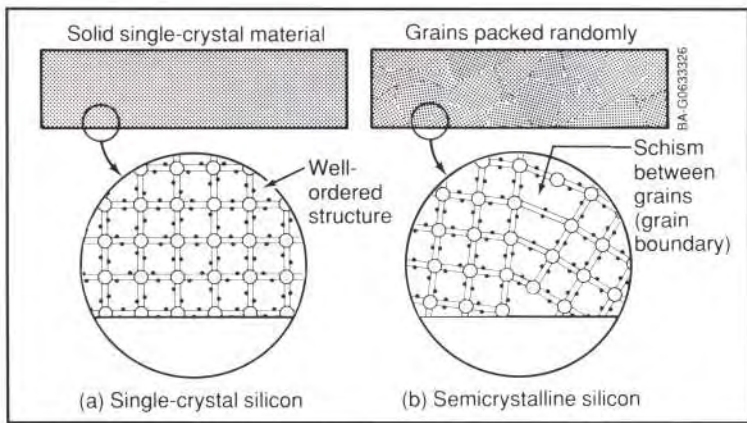

Single-crystal material (a) is structurally uniform; there are no disturbances in the orderly arrangement of atoms. Semicrystalline material (b) is made up of several crystals or grains. At the interfaces of the grains, known as grain boundaries, the atomic order is disrupted. This provides an area where electrons and holes are more likely to recombine.

that have been studied, several have become commercially significant or show great promise for future commercial success.

Semicrystalline and Polycrystalline Silicon Cells

The term “single-crystal” means that all the atoms in the active PV cell are part of a single crystalline structure, and there are no disturbances in the orderly arrangements of atoms. “Semicrystalline,” as used here, describes a PV cell in which the active portion of the cell is made up of several relatively large crystals, called grains, each about a square centimeter or so in area.

Semicrystalline Silicon

Having several large crystals in a cell introduces a problem. Charge carriers can move around relatively freely within one crystal, but what happens at

the interface between two crystals? At this “grain boundary,” the atomic order is disrupted. Free electrons and holes are much more likely to recombine at grain boundaries than within a single crystal. The same is true, by the way, at other kinds of interfaces—crystal/metal grid; crystal/top surface, etc. Recombination looks like a loss of current or a short circuit to the external electrical circuit. The grain boundaries look like an internal electrical resistance to the solar cell circuit, which

causes a loss of voltage from the cell. The net effect of grain boundaries is to reduce the power output of a solar cell.

Researchers have found several ways to minimize the problems caused by grain boundaries: adjusting growth conditions through treatments such as annealing (heating and then cooling) the semiconductor material so that grains are columnar and as large as possible; designing cells so that the charge carriers are generated within or very close to the built-in electric field; and

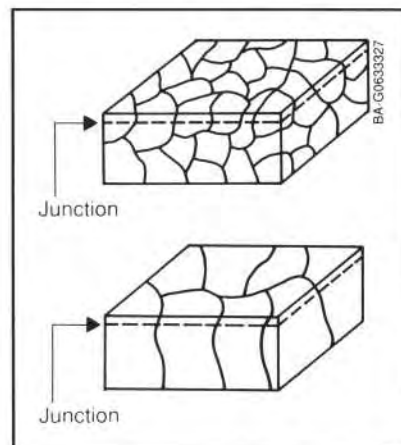

Heating and then cooling semicrystalline silicon can change randomly oriented grains (a) into larger, columnar ones (b), which alleviates problems with recombination at grain boundaries.

- Semicrystalline silicon is made up of several relatively large crystals, or grains.
- The interface between grains, or grain boundary, disrupts the atomic order and provides a place for free electrons and holes to recombine.
- Because of recombination, grain boundaries reduce the power output of a cell.
- Effects of grain boundaries can be minimized through special design, heating and then cooling the material, or filling the broken bonds.

- Generally, semi-crystalline silicon cells are not as efficient as single-crystal silicon cells, but they cost less.
- Semicrystalline silicon cells captured 33% of the PV market in 1990, compared to 35% for single-crystal silicon.
- The most popular method for making semicrystalline cells is casting, in which molten silicon is poured into a mold and allowed to solidify.
- Polycrystalline silicon is comprised of grains that are on the order of 1/1000th the size of grains in semi-crystalline silicon.

filling broken bonds at grain edges with elements such as hydrogen or oxygen, which is called passivating the grain boundaries.

Although these methods are effective in increasing the output of semicrystalline (as well as polycrystalline) solar cells, the processes that occur at the atomic level are not well understood.

Semicrystalline silicon cells cannot reach quite as high efficiencies as single-crystal silicon. Lower manufacturing costs, however, have made semicrystalline silicon very popular. In 1990, cells from semicrystalline silicon captured almost 33% of the world PV market, compared with about 35% for single-crystal silicon.

Semicrystalline silicon can be produced in a variety of ways. The most

The most popular method for making commercial semicrystalline silicon is casting, in which molten silicon is poured directly into a mold and allowed to solidify into an ingot.

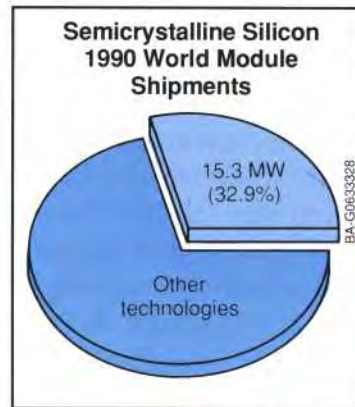
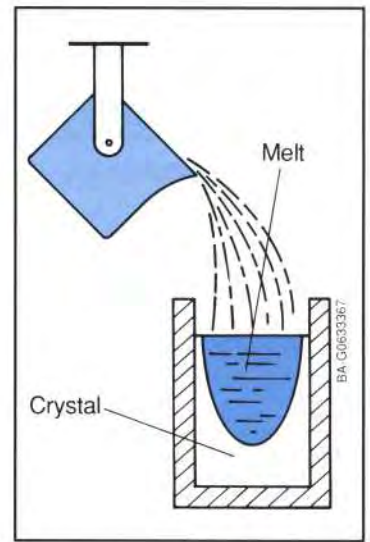

With 15.3 million watts of modules shipped in 1990, semicrystalline silicon captured 32.9% of the world PV market.

popular commercial methods involve a casting process in which molten silicon is directly cast into a mold and allowed to solidify into an ingot. Generally the mold is square, producing an ingot

that can be cut and sliced into square cells to fit more compactly into a PV module (see Chapter 4 on “packing efficiency”).

Polycrystalline Silicon

Even very small crystals of silicon make successful solar cells. At least one company is working on developing solar cells made from thin polycrystalline silicon. In these cells, single-crystal grains are only about 40 to 100 microns in diameter, about the thickness of a human hair. Crystals in semicrystalline silicon, on the other hand, are 1,000 times larger.

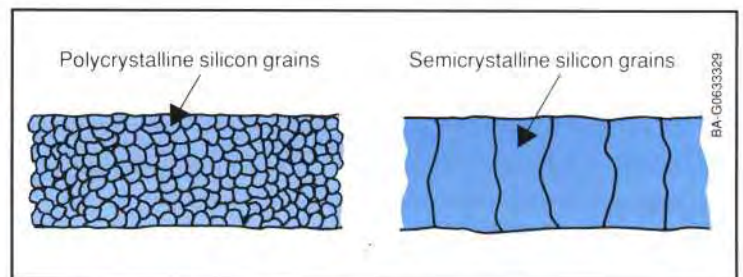

The grains in polycrystalline silicon (a) are on the order of 1000 times smaller than grains in semicrystalline silicon (b).

Thin-Film Solar Cells

One of the scientific discoveries of the computer semiconductor industry that has shown great potential for the PV industry is thin-film technology. Thin films are exceedingly fine layers of semiconductors placed on top of each other. Thin-film cells can be made from a variety of materials. Today, the most widely used commercial thin-film cells are made from amorphous silicon. Two other materials that are on the verge of commercialization, showing great promise for low-cost production, are polycrystalline copper indium diselenide and cadmium telluride.

Thin-film devices require very little material and have the added advantage of being easy to manufacture. Rather than by growing, slicing, and treating a crystalline ingot, we make them by sequen-

tially depositing thin layers of the required materials. Several different deposition techniques are available, all of them potentially cheaper than the ingot-growth techniques required for crystalline silicon. These deposition processes can easily be scaled up so that the same technique used to make a 2-inch x 2-inch laboratory cell can be used to make a 2-foot x 5-foot module. The layers can be

deposited on various low-cost substrates. These can be glass or plastic in virtually any shape—even flexible plastic sheets.

While single-crystal cells have to be individually interconnected into a module, thin-film devices can be made monolithically (as a single unit). Layer upon layer is deposited sequentially on a glass superstrate, from the antireflection coating and conducting oxide, to the

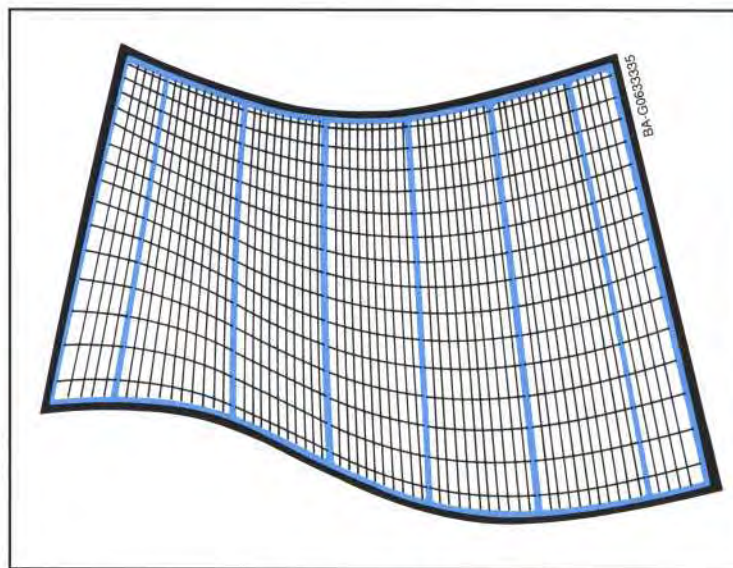

Thin-film modules can be deposited on a variety of low-cost substrates, including glass and flexible plastic sheets.

- Thin-film solar cells are made of exceedingly thin layers of semiconductor material.
- Today's most important thin-film materials are amorphous silicon, copper indium diselenide, and cadmium telluride.
- Thin-film devices, which require very little material and do not need to be grown or sliced, use manufacturing processes that can easily be scaled up.
- Entire modules may be built as a single unit; layer upon layer is deposited on a substrate.

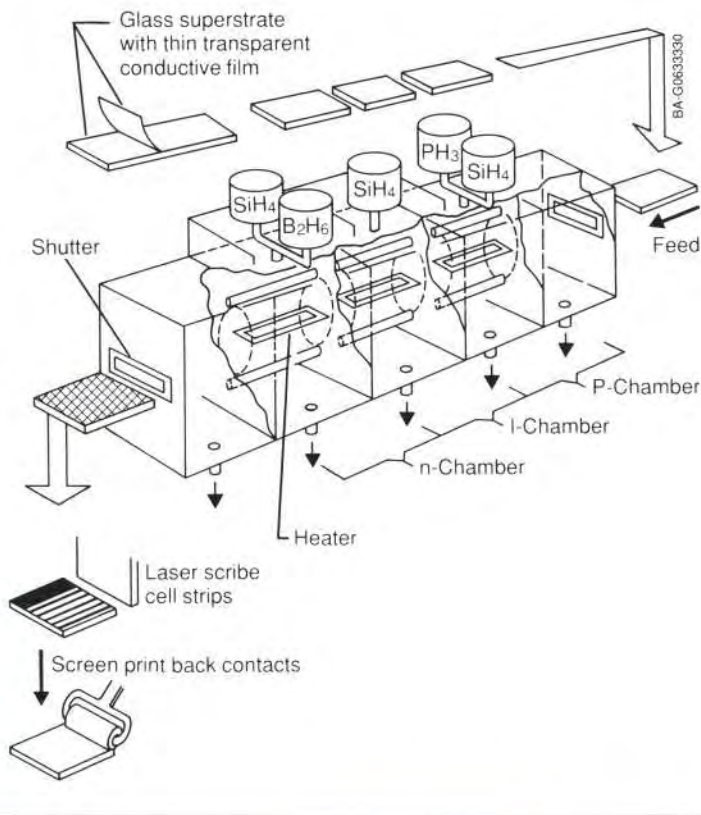

Thin-film modules are built as a single unit: layer upon layer is deposited sequentially on a glass superstrate, from the antireflection coating and conducting oxide, to the semiconductor material, to the back electrical contacts. Individual cells are formed by scribing with a laser.

- Individual cells are formed by scribing with a laser.
- Instead of metal grids to collect the current, thin-film devices typically use oxides that are transparent and that conduct electricity very well.
- Amorphous silicon (a-Si) was first classified as an insulator.
- But by modifying its composition slightly, a-Si becomes suitable for use in PV devices.
- In 1990, in fact, a-Si captured more than 31% of the world PV market.

semiconductor material, to the back electrical contacts. Individual cells are formed by scoring each layer with a laser beam.

Unlike most single-crystal cells, the typical thin-film device does not use a metal grid for the electrical contact. Instead, it uses a thin layer of a transparent conducting oxide. These oxides, such as tin oxide, indium tin oxide, and zinc oxide, are highly transparent and conduct electricity very well. They collect the current effectively from the top of the cell, and losses due to resistance are minimal. A separate antireflection coating may be used to top off the device, or the transparent conducting oxide may serve this function as well.

Amorphous Silicon

Amorphous solids, like common glass, are materials in which the atoms are not arranged in any particular order. They do not form crystalline structures at all, and contain large numbers of structural and bonding defects.

It wasn't until 1974 that researchers began to realize that amorphous silicon could be used in PV devices. Before then, the electrical properties of the material were classified as an insulator, and not at all like those of crystalline silicon or similar semiconductor materials.

This perception changed with the discovery that, by properly controlling the conditions under which it is deposited and by care-

fully modifying its composition, we can use amorphous silicon in PV cells. Today, amorphous silicon is commonly used for solar-powered consumer devices that have low power requirements. Amorphous silicon modules captured a little more than 31% of the world's solar cell market in 1990.

In recent years, the efficiency of amorphous silicon PV devices has steadily increased; laboratory cells with efficiencies greater than 13% were reported in 1989. Other new thin-film materials have reported much greater efficiencies—such as gallium arsenide cells, with efficiencies of more than 24% in unconcentrated light. But amorphous

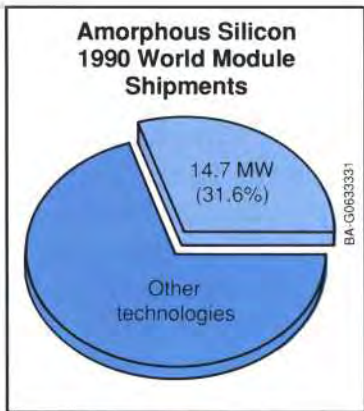

With 14.7 million watts of modules shipped in 1990, amorphous silicon captured 31.6% of the world PV market.

silicon solar cells, like polycrystalline thin-film devices (see page 32), are uniquely designed for low cost.

Properties of Amorphous Silicon

Amorphous silicon absorbs solar radiation 40 times more efficiently than does single-crystal silicon. As a result, a film only about 1 micron thick can absorb 90% of the usable solar energy; this is one of the most important factors affecting its potential for low cost. Other principal economic advantages are that amorphous silicon can

be produced at a lower temperature and deposited on low-cost substrates.

Amorphous silicon does not have the structural uniformity of crystalline silicon, nor even of polycrystalline silicon. There is a short-range order in the sense that most silicon atoms tend to bond with four other silicon atoms at distances and angles nearly the same as in a crystal. But this uniformity does not translate well among units, resulting in small deviations that destroy the

capability for long-range order. This lack of order results in a high degree of defects such as dangling bonds, where atoms are missing a neighbor to which they can bond. These defects provide places for electrons and holes to recombine. Ordinarily, such a material would be unacceptable for electronic devices because the defects limit the flow of current, in much the same way that grain boundaries interfere with the flow of current in polycrystalline material.

- A-Si absorbs light 40 times more efficiently than does single-crystal silicon and can be deposited on low-cost substrates.
- A-Si has a high degree of structural and bonding defects that provide places for electrons and holes to recombine, limiting current flow.

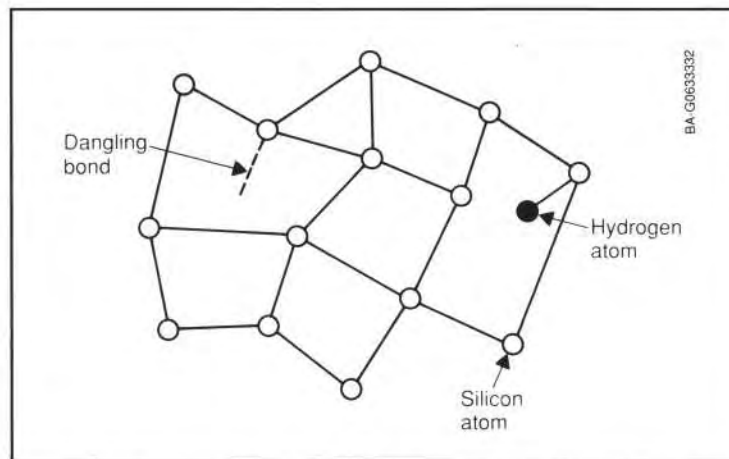

Amorphous silicon has no long-range order. Dangling bonds can arise to form centers for electrons and holes to recombine, effects that may be neutralized somewhat with hydrogen.

- Adding a small amount of hydrogen neutralizes some of the defects and enhances the mobility of electrons and holes.
- Because of the high number of defects, devices made of a-Si cannot use a p-n structure.
- A-Si devices use a p-i-n structure in which an undoped or intrinsic (i) layer is sandwiched between a p-layer and an n-layer.
- The p- and n-layers induce an electric field across the intrinsic layer, where charge carriers are generated.

But if amorphous silicon is deposited in such a way that it contains hydrogen (only a 5% to 10% concentration is required), then the hydrogen atoms combine chemically with some of the dangling bonds and remove them. Removing the dangling bonds results in a small but extremely important enhancement of the freedom of movement, or mobility, of electrons and holes in amorphous silicon.

Even with this remedy, electrons and holes are much less mobile in hydrogenated amorphous silicon than in crystalline silicon. Doping makes this already low mobility even worse. Therefore, the design of amorphous silicon PV cells is quite different from the p-n junction design used in crystalline silicon PV cells.

Hydrogenated amorphous silicon cells are designed to have an ultra-thin (0.008-micron) and highly doped p+ top layer; a thicker (0.5- to 1-micron)

undoped intrinsic (middle) layer; and a very thin (0.02-micron) n+ bottom layer. The top layer is made so thin and relatively transparent that most incident light passes right through it, to generate electron-hole pairs in the undoped intrinsic layer. The top p+ and the bottom n+ layers induce an electric field across the entire intrinsic, or middle, region in a manner similar to the induction of an electric field in the p-n junction of a crystalline silicon PV cell. Since the

charge carriers are generated in the intrinsic layer, the poor charge mobility in the doped p+ and n+ layers is less important.

Amorphous silicon has a band-gap energy of about 1.7 eV, which is greater than crystalline silicon's band-gap energy of 1.1 eV. A PV cell's output voltage is directly related to the size of its band gap, so PV cells made of amorphous silicon have higher output voltages than cells made of crystalline silicon. The higher

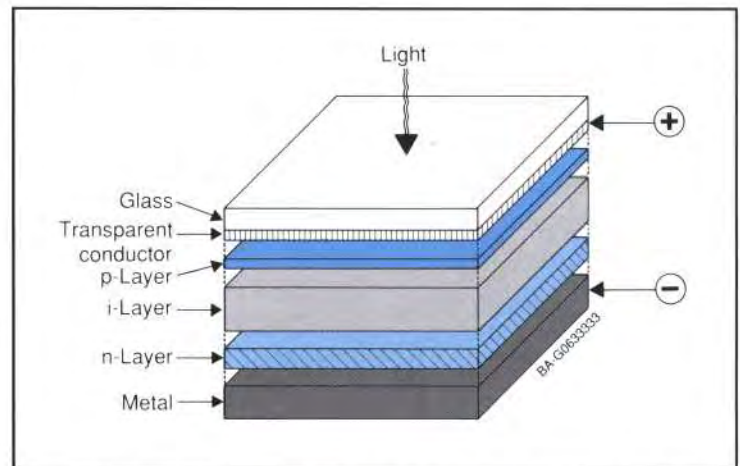

The typical amorphous silicon cell employs a p-i-n design, in which an undoped or intrinsic layer is sandwiched between a p-layer and an n-layer.

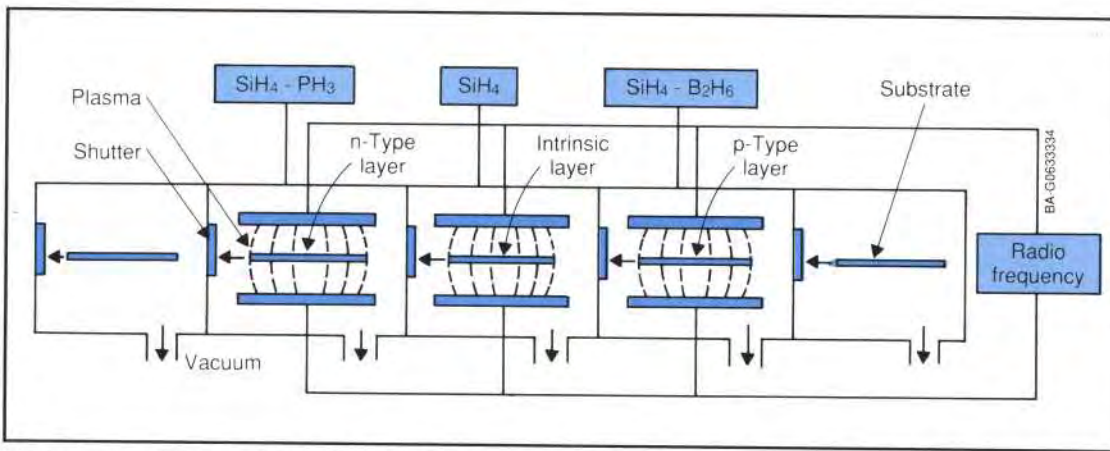

Most commercial amorphous silicon modules are made with glow-discharge deposition. Doped and intrinsic amorphous silicon layers are deposited in sequence as the module moves through consecutive chambers. Doping is done in different chambers by adding diborane or phosphine to the silane.

output voltage compensates for the fact that lower-energy photons (with energies below 1.7 eV) are not absorbed by amorphous silicon.

Typically, the construction of a hydrogenated amorphous silicon p-i-n cell begins with the deposition of a p+ layer onto a textured transparent conducting tin-oxide film (the top electrode). This is followed by the intrinsic (i) layer, and a thin n+ layer. The cell is then given a reflective coating on the bottom, usually of aluminum or silver. A textured transparent conducting oxide substrate and a reflector help to trap the maximum possible amount of light in the PV cell.

Glow-discharge deposition has been the method used to make the most efficient amorphous silicon PV cells. In the most common form of this method, a stream of silane (SiH_4)

and hydrogen gas is passed between a pair of electrodes whose polarity is reversed at high frequency. This reversal of the voltage induces an oscillation of energetic electrons between the electrodes. The electrons collide with the silane, breaking it down into SiH_3 and hydrogen. Since SiH_3 is chemically a radical, and hence unstable, it adheres to a substrate on one of the electrodes to gain stability. Hydrogen is then released from the substrate, leaving a film of amorphous silicon with about 10% hydrogen. Doping can be accomplished by adding diborane (B_2H_6) or phosphine (PH_3) gas to the silane.

Most commercial amorphous silicon PV modules are produced by this method. The successive layers of the module are formed by moving the substrate sequentially to dif-

ferent electrode stations in separate chambers and depositing the appropriate materials, one at a time. Moving the modules through different chambers minimizes the opportunity for contamination from previous steps. This process uses little energy and is potentially able to produce modules a few square feet in area, on a variety of substrates, and in an assortment of shapes.

Stability Problems and Solutions

After amorphous silicon modules are first exposed to light, their conversion efficiency decreases by 10% to 20%. Thereafter, their performance is relatively steady. Researchers have long studied this light-induced instability. Several explanations have been offered, including tiny microvoids in the amorphous silicon material. Microvoids are atomic-level gaps in the structure several angstroms

- With a 1.7 eV band gap, a-Si cells have higher output voltages than crystalline silicon cells, but are less efficient and produce less power.
- Most a-Si devices are made by glow-discharge deposition, in which a high frequency is used to break down silane gas (SiH_4) to deposit hydrogenated silicon.
- After a-Si devices are first exposed to light their efficiency decreases by 10% to 20%.

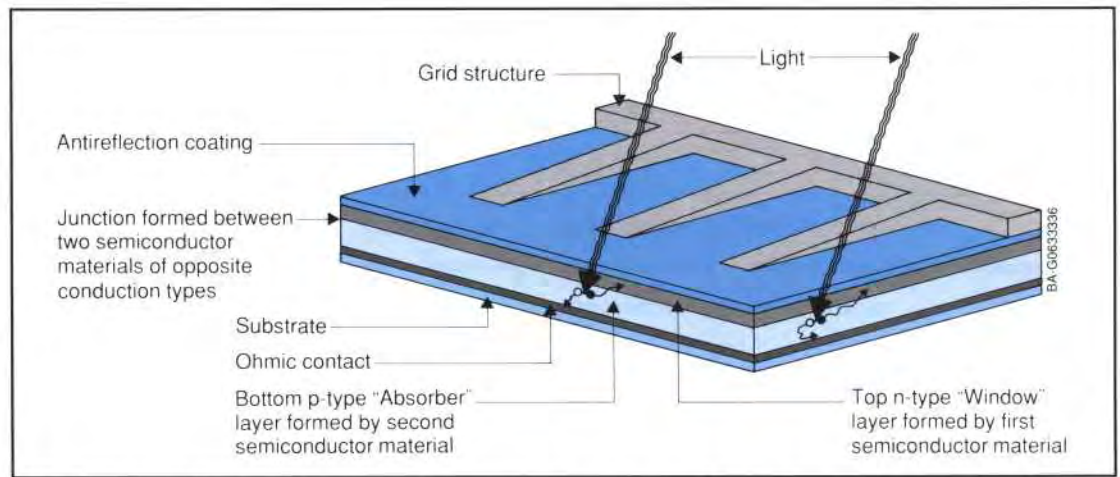

Polycrystalline thin film cells have a heterojunction structure, in which the top layer is made of different semiconductor material than the bottom semiconductor layer. The top layer, usually n-type, is a window that allows almost all of the light through to the absorbing layer, usually p-type.

- This degradation can be partly neutralized through annealing.
- Polycrystalline thin film cells comprise many tiny crystalline grains of semiconductor material.
- These devices use a heterojunction structure with the junction formed between two different semiconductor materials.
- The top layer is a high-band-gap "window" that allows the light through to the bottom layer, which absorbs photons and generates charge carriers.
- Copper indium diselenide (CIS) is a very stable PV material with very high absorptivity.

in diameter (an angstrom is one-ten billionth of a meter). Other causes proposed include oxygen or carbon impurities that are in the cells and ordinary stresses in the system that break silicon-silicon bonds in the region of the imperfections. Researchers have found that devices suffering from degradation can recover their effectiveness if they are annealed at 150°C for a few minutes. Annealing is somewhat effective even at the normal operating temperatures of PV modules, about 50° to 80°C. This is called self-annealing, and it is being looked at by manufacturers of amorphous silicon PV cells.

Polycrystalline Thin-Film Solar Cells

Polycrystalline thin-film cells comprise many tiny crystalline grains of semiconductor materials. The materials used in polycrystalline thin-film cells have properties that are different from those of silicon. For these devices, it has proven to be better to create the electric field with an interface between two different semiconductor materials. This type of interface is called a heterojunction ("hetero" because it is formed from two different materials, in comparison to the "homojunction" formed by two doped layers of the same material, such as the one in silicon solar cells).

The typical polycrystalline thin film has a very thin (less than 0.1 micron) layer on top called the "window" layer. The window layer's role is to absorb light energy from

only the high-energy end of the spectrum. It must be thin enough, have a wide enough band gap (2.8 eV or more), and have a low enough absorptivity to let all the available light through the interface (heterojunction) to the absorbing layer. The absorbing layer under the window, usually doped p-type, has to have a high absorptivity for high current and a suitable band gap to provide a good voltage. It is typically 1 to 2 microns thick.

Copper Indium Diselenide

Copper indium diselenide (CuInSe₂, or CIS) has an extremely high absorptivity that allows 99% of the available incident light to be absorbed in the first micron of the material. But that is not the only reason that copper indium diselenide is attractive for PV devices. It also has shown very good stability in outdoor

tests, an important criterion for commercialization. Recent outdoor tests show no degradation in this material after many hours.

The most common material for the window layer in CIS devices is cadmium sulfide (CdS); sometimes zinc is added to improve the transparency. Adding small amounts of gallium to the absorbing CIS layer boosts the band gap of CIS (from its normal 1.0 eV), which improves the voltage and therefore the efficiency of the device.

The layers of materials in CIS cells can be made by several different processes that were developed in the computer-related thin-film industry. All of these methods are well established commercially in various industries. The CIS layer itself consists of three different elements—copper, indium, and selenium. One of the most popular preparation methods for the CIS layer

is evaporation. Small amounts of each of the elements are electrically heated to a point where the atoms vaporize. They then condense on a cooled substrate to form a CIS layer.

Another common method is sputtering. High-energy ions bombard the surface, driving off atoms of the target material. These then condense on a substrate to form a thin layer.

Another technique used successfully to deposit copper indium diselenide on a substrate is spray pyrolysis. In this method, solutions of the salts of the necessary elements are sprayed onto a hot substrate. They react under the elevated temperatures to form the required CIS layer, while the solvent evaporates.

Electrodeposition can also be used to form the CIS layers in the same way

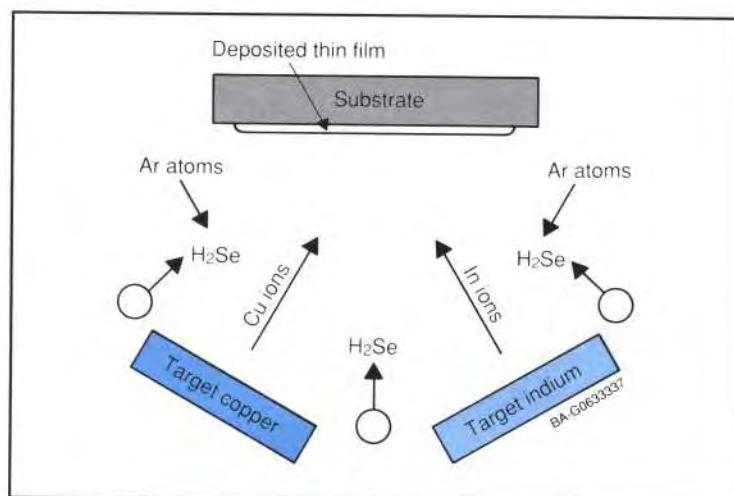

In the sputtering method for making CIS modules, high-energy atoms of a noble gas like argon (Ar) strike two targets, one of copper (Cu) and one of indium (In). This sends beams of Cu and In ions toward a substrate. A gas containing selenium (hydrogen selenide, H_2Se) interacts with the copper and indium ions to form $CuInSe_2$ on the substrate.

- CIS devices generally use cadmium sulfide for the window layer and sometimes add gallium to the CIS absorbing layer to boost the band gap from its normal 1.0 eV.
- One way to make CIS is to heat copper, indium, and selenium, whose atoms vaporize and then condense on a substrate to form CIS.
- Other methods for making CIS include spray pyrolysis, sputtering, and electrodeposition.

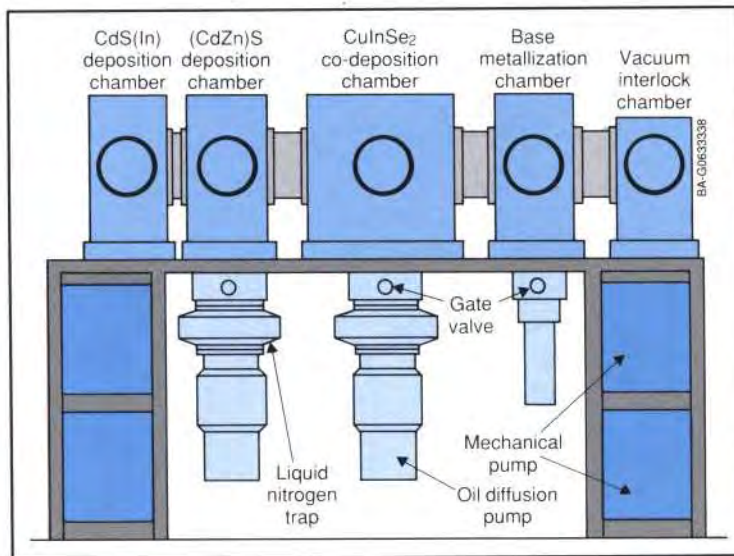

Sputtering of an entire CIS module can be done by using an in-line system such as this, where the module is moved through the chambers sequentially to deposit the base metallization and the absorber and window layers.

- CIS cells have exceeded 14% efficiency and modules have reached 11%, the highest for thin-film devices.
- The other prominent polycrystalline material is cadmium telluride (CdTe), which has a nearly ideal band gap (1.44 eV) for PV.
- Like CIS, CdTe has high absorptivity, is very stable, and can be manufactured with several of the same low-cost techniques.

gold is plated onto jewelry. Passing electricity through a solution containing ions of the required elements causes them to be deposited out of solution onto an electrode, which acts as the substrate.

CIS layers can also be made by using one of these methods to deposit only the copper and the indium. This is followed by a treatment with hydrogen selenide gas (called selenization) to add the

selenium. This approach is considered the most likely to lead to commercial CIS products.

Laboratory cells of CIS recently exceeded 14% efficiency. One-square-foot submodules achieved an efficiency above 11%, generating more than 10 W of power. A 1-foot x 4-foot module reached 9% efficiency, generating 36 W. At least one major company expects to commercialize CIS soon.

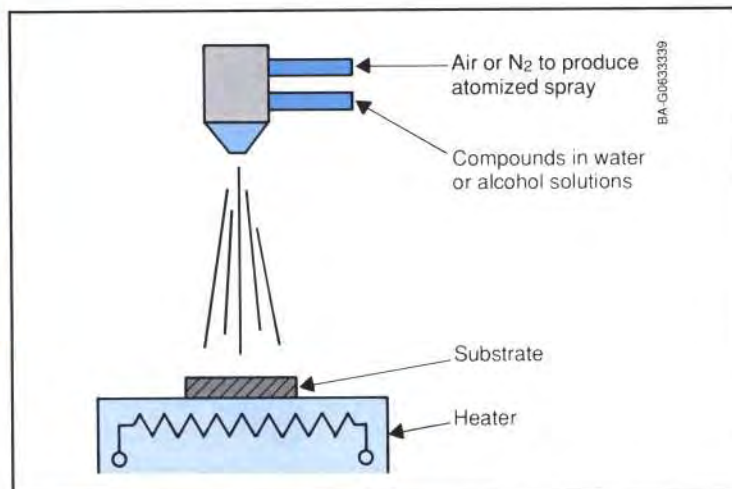

Spray pyrolysis has the potential to be a low-cost deposition method for polycrystalline thin-film devices. For CIS cells, solutions containing reacting species of copper, indium, and selenium are sprayed onto a heated substrate where they react to form a CIS layer.

Cadmium Telluride

The other prominent polycrystalline thin-film material is cadmium telluride (CdTe). With a nearly ideal band gap of 1.44 eV, cadmium telluride also has a very high absorptivity. Although cadmium telluride is most often used in PV devices without being alloyed, it is easily alloyed with zinc, mercury, and some other elements to vary its properties. Cadmium telluride films can be manufactured by the same low-cost techniques used to make CIS films, especially electro-deposition and spraying.

Like CIS, the best CdTe cells employ a heterojunction interface, with cadmium sulfide acting as a thin window layer. Tin oxide is used as a transparent conducting oxide and an antireflection coating.

Though CIS can easily be prepared p-type, cadmium telluride is not so well behaved. P-type CdTe films tend to be highly

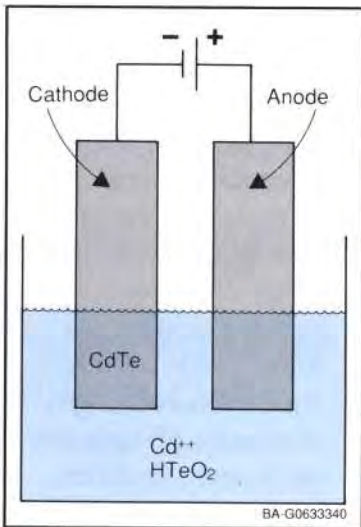

Like spray pyrolysis, electro-deposition carries a history of industrial application and promises low-cost fabrication for polycrystalline thin-film devices. To make cadmium telluride devices a current is passed through an electrolyte containing cadmium and tellurium ions, causing CdTe to deposit on the cathode.

resistive electrically, which leads to large internal losses. It has been difficult to make a stable back electrical contact, because a rust-like deterioration develops there. Two approaches have been successful in circumventing this problem. One approach is to avoid trying to dope the CdTe layer p-type. The CdTe

layer is instead allowed to be intrinsic (natural, neither p-type nor n-type). Then, a layer of p-type zinc telluride (ZnTe) is sandwiched between the cadmium telluride and the back electrical contact. Even though the n-type cadmium sulfide and the p-type zinc telluride are separated, they still form an electrical field that extends right through the intrinsic cadmium telluride. Cells employing this design have been tested for more than 3,000 hours and have shown no degradation.

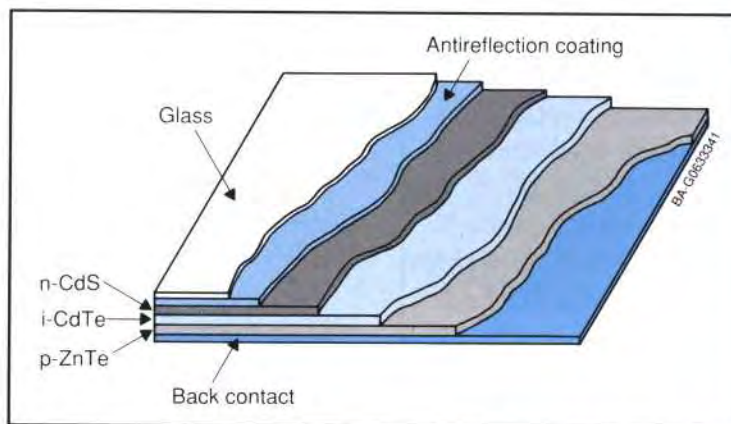

One way around contacting problems inherent in typical CdTe cells is to use an n-i-p structure, with an intrinsic layer of CdTe sandwiched between an n-type CdS layer and a p-type ZnTe layer.

One company using the more conventional p-type CdTe cell structure has also developed new CdTe contacts that appear to be stable if properly protected from water vapor and oxygen. To achieve this, the firm is developing a hermetically sealed module.

By 1989 the highest efficiencies measured for laboratory CdTe cells were greater than 12%, and for modules, greater than 7%. Some companies plan to deliver commercial modules of CdTe soon.

- Because of its high electrical resistivity, it has been difficult to attach back contacts to p-type CdTe.
- One way to get around this problem is to use a p-i-n structure, with intrinsic (i) CdTe sandwiched between n-cadmium sulfide and p-zinc telluride.
- Another way around the problem is to develop stable contacts and protect them from water and oxygen.
- CdTe cells and modules have been measured with efficiencies as high as 12% and 7%, respectively.

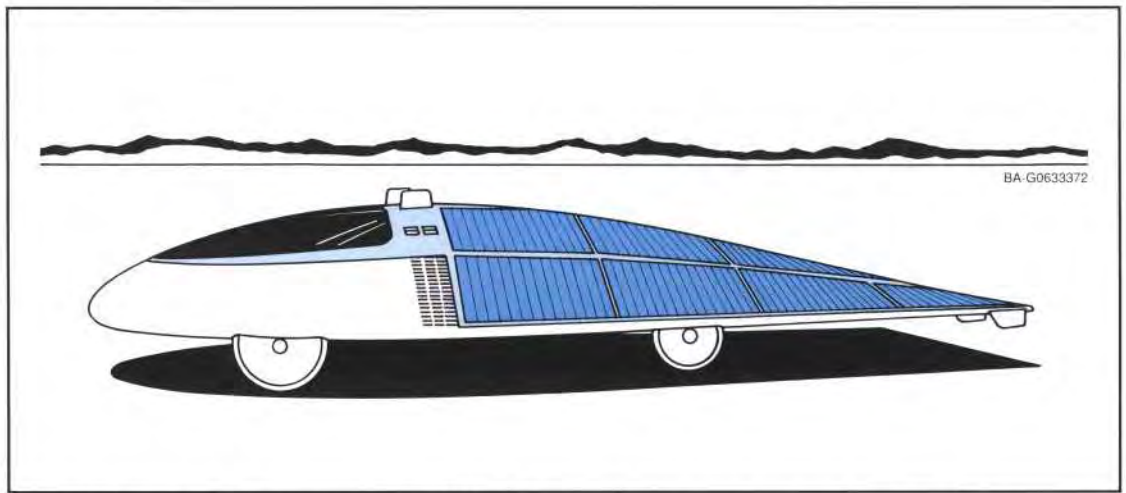

Using GaAs cells, the Sunraycer built by GM and Hughes Aircraft won the transAustralian Solar Challenge race in 1987, averaging more than 41.6 mph.

- Gallium arsenide (GaAs) cells have been running nip and tuck with single-crystal silicon in the race for the highest efficiency PV device.
- GaAs has many desirable properties. It has an ideal band gap (1.43 eV), is highly absorptive, is relatively insensitive to heat, can be alloyed with many materials, and is radiation resistant.

Gallium Arsenide Solar Cells

Gallium arsenide (GaAs) is a compound semiconductor, a mixture of two elements, gallium (Ga) and arsenic (As). Gallium is a by-product of the smelting of other metals, notably aluminum and zinc, and is rare—rarer than gold, in fact. Arsenic is not rare but is poisonous. Gallium arsenide for solar cells has been developing synergistically with gallium arsenide for light-emitting diodes, lasers, and other optoelectronic devices.

Single-crystal silicon and single-crystal GaAs cells have been running nip and tuck in the race to the highest-efficiency PV device. In 1989, experimental silicon cells reached efficiencies of nearly 23% under unconcentrated sunlight; experimental GaAs cells reached efficiencies of almost 26% under

unconcentrated light and 29% under concentrated light. Cells in commercial production can average as high as 20% efficient. It was this type of cell that powered the record-shattering performance of the GM Sunraycer in the Solar Challenge car race across Australia in 1987. Their high efficiency and their resistance to radiation have also made GaAs cells favorites for powering satellites and other spacecraft.

Properties of Gallium Arsenide

Gallium arsenide is quite suitable for use in high-efficiency solar cells for several reasons:

- The GaAs band gap is 1.43 eV, nearly ideal for single-junction solar cells.
- Gallium arsenide has a high absorptivity and requires a cell only a few microns thick to absorb sunlight. (Crystalline silicon requires a cell

100 microns or more in thickness.)

- Unlike silicon cells, GaAs cells are relatively insensitive to heat. (Cell temperatures are often quite high, especially for concentrator applications.)
- Alloys made from gallium arsenide using aluminum, phosphorus, antimony, or indium have characteristics complementary to those of gallium arsenide, allowing great flexibility in high-efficiency cell design.
- Gallium arsenide is very resistant to radiation damage. This, along with its high efficiency, makes GaAs very desirable for outer-space applications. In silicon cells, the p-n junction is formed by treating the top of a p-type silicon wafer with an n-type dopant. This process does not work with gallium arsenide. Instead, all the active parts of a GaAs solar cell are made by growing

sequences of thin, single-crystal layers on a single-crystal substrate. As each layer is grown, it is doped in different ways to form the p-n junction and to control other aspects of cell performance.

The GaAs layers are grown via one of two popular techniques: molecular beam epitaxy (MBE) or metal-organic chemical vapor deposition (MOCVD). In MBE, a

heated substrate wafer is exposed to gas-phase atoms of gallium and arsenic that condense on the wafer on contact and grow the thin GaAs film. In MOCVD, a heated substrate is exposed to gas-phase organic molecules containing gallium and arsenic, which react under the high temperatures, freeing gallium and arsenic atoms to adhere to the substrate. In both of these techniques,

single-crystal GaAs layers grow epitaxially—that is, the new atoms deposited on the substrate continue the same crystal lattice structure as the substrate, with few disturbances in the atomic ordering. This controlled growth results in a high degree of crystallinity and in high cell efficiency.

One of the greatest advantages of gallium arsenide and its alloys as PV cell materials is the wide range of design options possible. A cell with a GaAs base can have several layers of slightly different compositions that allow a cell designer to control the generation and collection of electrons and holes. (To accomplish the same thing, silicon cells have been limited to variations in the level of doping.) This degree of control allows cell designers to push efficiencies closer and closer to theoretical levels. For example, one of the most

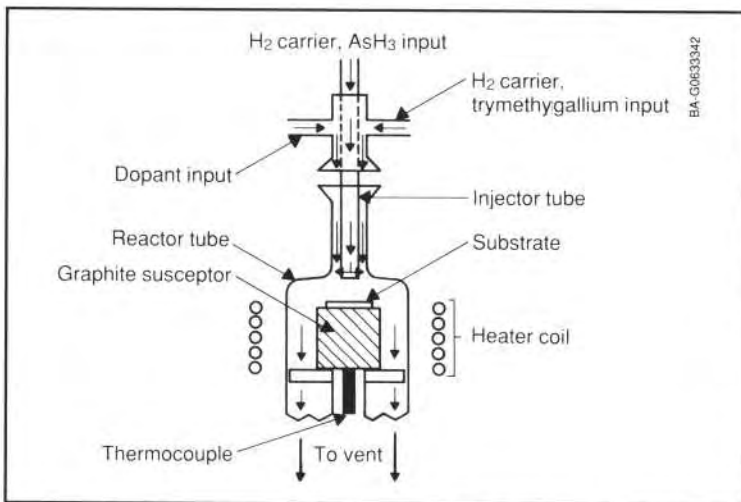

Gallium arsenide devices are often made by MOCVD, a process in which gas-phase molecules of gallium, arsenic, and dopants are injected onto a heated substrate. (Gallium, some of the dopants, and alloys are contained in organic compounds.) The molecules react under the high temperatures, freeing gallium and arsenic atoms to adhere to the substrate.

- GaAs devices are made via either molecular beam epitaxy or metal organic chemical vapor deposition.
- Each technique offers precise growth control and results in high degrees of crystallinity and high cell efficiencies.
- One of the greatest advantages of GaAs and its alloys is the wide range of design options available.
- A designer can precisely alter the composition of each layer of a GaAs-based cell to control the generation and collection of charge carriers.

- Per square meter, the cost of a single-crystal GaAs substrate is high: ~ \$10,000.
- Per concentrator cell, which is typically 0.25 cm², the cost of the GaAs substrate is about 25¢.
- One way to cut the cost is to use cheaper substrates, like germanium and silicon.
- The crystal structure and thermal properties of silicon and germanium, however, do not match those of GaAs; hence cells grown with them are lower quality.

common GaAs cell structures uses a very thin window layer of aluminum gallium arsenide. The thin dimension of the layer allows charge carriers to be created close to the electric field at the junction.

Lowering the Cost of Gallium Arsenide Cells

The largest barrier to the success of GaAs cells for terrestrial use has been the purportedly high cost of a single-crystal GaAs substrate, estimated at as much as \$10,000 per square meter. Although this sounds formidable, it is an oversimplification of the situation.

First, nobody makes square meters of single-crystal gallium arsenide; the \$10,000 cost is projected from that of much smaller substrates.

Second, GaAs cells are used primarily in concentrator systems. The typical concentrator cell is approximately 0.25 cm² in

area and can produce ample power under high concentrations. So, at \$10,000 per square meter, the substrate for a typical GaAs cell would cost about 25¢. This cost is low enough to make GaAs cells competitive, assuming that module efficiencies can reach between 25% and 30% and that the cost of the rest of the system can be reduced.

Researchers are exploring two approaches to lowering the cost of GaAs devices. The first approach is to fabricate GaAs cells on cheaper substrates like silicon or germanium, rather than on the more expensive GaAs substrates. The other is to grow GaAs cells on a removable GaAs substrate that can be reused to produce other cells.

Growing good-quality GaAs crystals for solar cells requires a substrate with a crystal structure matching that of gallium arsenide and with similar thermal properties, i.e., the

amount of expansion and contraction that occurs with temperature. Naturally, gallium arsenide itself works best as a substrate. But silicon and germanium can also be used. These materials make cheaper and more durable substrates than gallium arsenide. But the slight mismatch in crystal structures between Si or Ge and GaAs causes imperfections in the growing GaAs crystal. One way around this problem is to grow a relatively thick buffer layer of gallium arsenide between the silicon and the active GaAs cell; the buffer layer then absorbs many of the imperfections in the crystal structure. Another way is to treat cells with hydrogen, as we treat semicrystalline silicon, which lessens the effects of imperfections.

The highest efficiencies of GaAs-on-Si cells obtained in 1989 exceeded 22%. Several laboratories are working to improve our understanding of the

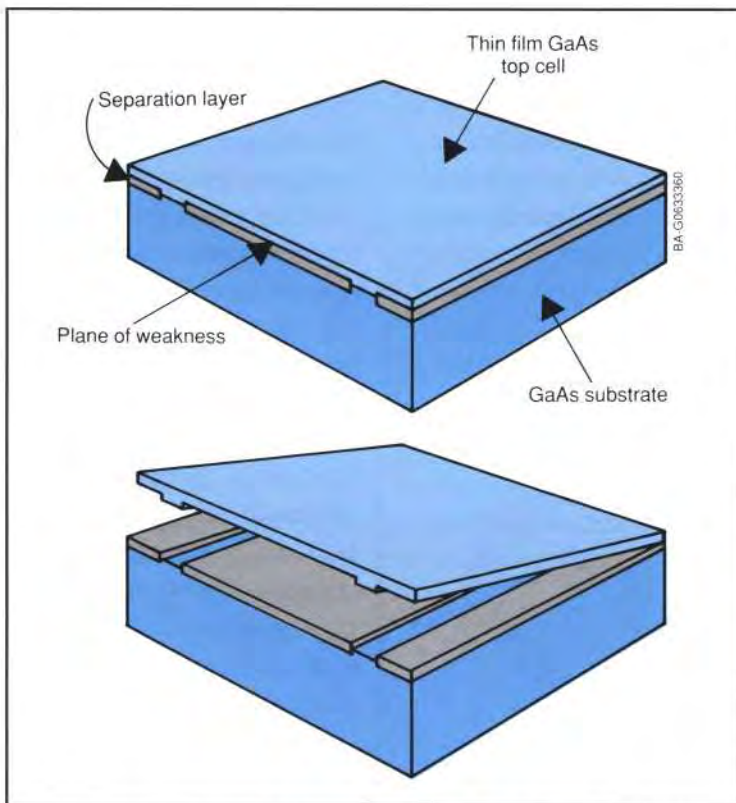

One way to cut the cost of gallium arsenide cells is to grow thin films of single-crystal gallium arsenide on a reusable gallium arsenide substrate. The thin films can be peeled off and incorporated in a PV device and the substrate can be used to grow several more thin films.

GaAs-on-Si material system, since GaAs-on-Si is becoming increasingly important not only for solar cells but also for high-speed microelectronic components—another example of the cross transfer of knowledge between

photovoltaic and semiconductor research.

In another attempt to reduce costs, one U.S. company is growing thin films of single-crystal gallium arsenide onto thick, reusable substrates of the same material. These thin films

can then be peeled off and incorporated in a PV device; and the substrate can then be used to grow several more thin films. Photovoltaic cells made from this process, which can deliver efficiencies of about 24%, were used to make an experimental flat-plate module at a record efficiency—greater than 20%.

Multijunction Devices

Today's most common PV devices use a single junction, or interface, to create an electric field. In a single-junction PV cell, only photons whose energy is equal to or greater than the band gap of the cell material can kick an electron up into the conduction band. In other words, the photovoltaic response of single-junction cells is limited to the portion of the sun's spectrum whose energy is above the band gap of the absorbing material.

- Another way to lower costs is to reuse the GaAs substrate to grow several cells — an approach that has resulted in 24%-efficient cells.
- Single-junction cells restrict efficiency because their PV response is limited to a small part of the solar spectrum.

- **Multijunction devices stack two or more cells atop each other to capture more of the solar spectrum.**
- **High band-gap cells capture the high-energy part of the spectrum and the low band-gap cells capture the low-energy part of the spectrum.**
- **Multijunction devices may be able to reach efficiencies as high as 20% for thin films and 40% for single-crystal.**
- **We make multijunction devices either by mechanically stacking individual cells or by sequentially growing one cell on top of another (monolithically).**

Lower-energy photons are not used.

One way to get around this limitation is to use two (or more) different cells, with more than one band gap and more than one junction, to generate a cell voltage. These are referred to as multijunction cells (also called cascade or tandem cells). Multijunction devices can achieve a higher total conversion efficiency because they can convert more of the energy spectrum of light to electricity.

Thin-film, multijunction cells, which are used in flat-plate configuration (see Chapter 4), are nearing efficiencies of 15% or more. In the future, these cells are expected to reach efficiencies of approximately 20%. Single-crystal, multijunction cells, on the other hand, have already recorded efficiencies greater than 30% and may eventually reach efficiencies of 40% or more. Although not yet commercially ready, these cells

hold great promise for use in concentrator PV systems (see Chapter 4).

In a typical multijunction PV cell, individual single-junction cells with different energy band gaps (E_g) are stacked on top of each other. Sunlight falls first on the material having the largest band gap,

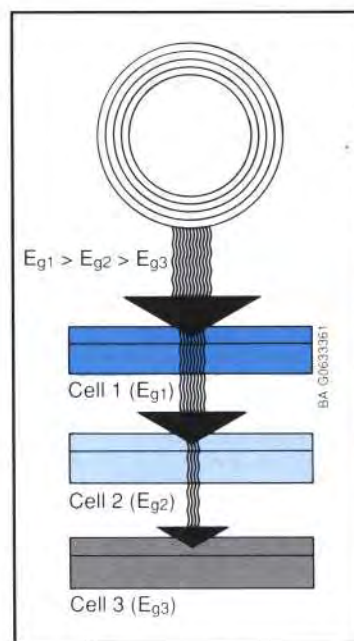

A multijunction device stacks individual single-junction cells on top of each other in descending-band-gap order. The top cell captures the high-energy photons and passes the rest of the photons on to be absorbed by lower-band-gap cells.

and the highest-energy photons are absorbed. Photons not absorbed in the first cell are transmitted to the second cell, which absorbs the higher-energy portion of the remaining solar radiation while remaining transparent to the lower-energy photons. In theory, any number of cells can be used in multijunction devices. Practical experience to date has shown that two or three cells make up the most workable multijunction design.

Multijunction cells are made in one of two basic ways: monolithic or mechanically stacked. Monolithic multijunctions are made by sequentially growing all the necessary layers of materials for two cells and the interconnection between the cells, one layer on top of another. With mechanically stacked multijunctions, different cells are made separately, stacked on top of one another, and stuck

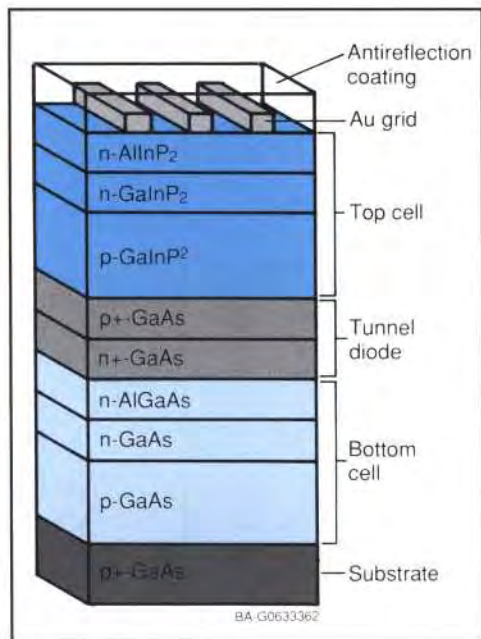

This monolithic multi-junction device uses a top cell of gallium indium phosphide, a tunnel junction, and a bottom cell of gallium arsenide. Devices with this structure have achieved efficiencies greater than 27% under concentrated sunlight.

together with transparent adhesive. Each approach has its advantages, and both are currently being investigated at DOE laboratories and in industry.

High-Efficiency/ GaAs

Much of today's research in multijunction cells focuses on gallium arsenide as one (or all) of the component cells. In 1988, a mechanically stacked device reached 31% efficiency under concentrated sunlight, which was a new record for any type of photovoltaic device. It consisted of a GaAs cell on top of a single-crystal silicon cell. In 1990, a device that used GaAs for the top cell and gallium antimonide for the bottom cell achieved an efficiency of 34.2% under 100 suns concentration, a record that still holds as of this writing.

Lately, monolithic multi-junction devices, which face more difficult engineering and fabrication

challenges than do stacked devices, have seen their efficiencies climb dramatically. Two of these devices are especially worthy of note. In 1989, the best monolithic multijunction device exceeded 27% efficiency under unconcentrated sunlight. (Efficiencies tend to go up under concentrated sunlight because of the electrical and thermal properties of semiconductors.) The top cell was gallium indium phosphide, connected by a "tunnel junction" to a bottom cell of gallium arsenide. A tunnel junction allows charge carriers to move between the top cell and the bottom cell through a very thin insulating layer.

The other monolithic cell, a device that uses indium phosphide for the top cell and indium gallium arsenide for the bottom cell (InP/InGaAs), reached 31.8% efficiency under 50 suns concentra-

tion in 1990. There are several interesting things about this device. First, its design broke with the traditional thinking that, for highest efficiency in a two-junction device, the top cell should have a high band gap of approximately 1.9 eV while the bottom cell should have a band gap of about 1.4 eV. For this device, the band gap of the top cell is 1.35 eV and that of the bottom cell is about 0.75 eV.

Second, the cell is ideally suited for space applications because the resistance of indium phosphide to radiation is 50% better than that of silicon and 15% better than that of gallium arsenide, the two materials most widely used for PV power in space. This means that arrays using InP/InGaAs cells could be lighter, cheaper, more reliable, and longer lived and could provide more power.

- Most high - efficiency multi-junction devices depend on GaAs or its alloys and are made primarily for use under concentration.
- The record efficiency for all PV devices (34.2%) was set by a device that stacked a GaAs cell on a gallium antimonide cell.
- The record monolithic device (31.8%) used an indium phosphide cell on top of an indium gallium arsenide cell.

- A-Si multijunction devices are not only more efficient than single-junction ones, they also experience less light degradation.
- Multijunction devices use two or three a-Si cells stacked on top of each other.
- We can vary the band gap of a-Si by alloying with carbon, germanium, nitrogen, or tin.

Third, the band gap of indium gallium arsenide can be altered by varying the ratio of the constituent materials. This opens up possibilities for tuning the cell to meet special applications.

The devices that we have mentioned here are just the tip of the iceberg. Many other combinations of gallium arsenide and its alloys are being explored for use in high-efficiency multijunction devices.

Amorphous Silicon

Many advanced PV cell designs are used in making amorphous silicon devices, including silicon-carbon alloy p-i-n cells, n-i-p cells, and stacked cells. In many ways, the multijunction design is the most important recent advance in amorphous silicon research and development. Multijunction devices not only achieve higher efficiencies than single-junction ones, they

also experience less light-induced degradation. One reason for this is that there is less degradation in very thin cells with extremely thin intrinsic layers, such as the ones that make up multijunction devices.

Because the intrinsic layers are so thin, the electric field sweeps charge carriers from these layers with minimal recombination.

Multijunction devices use two, and sometimes

three, individual amorphous silicon cells stacked on top of each other. The cells can all be of the same material, with the same band gap. Or, to capture a broader portion of the sun's spectrum, the cells can be made of different materials with different band gaps. Amorphous silicon alloys with carbon, germanium, nitrogen, and tin have all been used to vary the band gap and

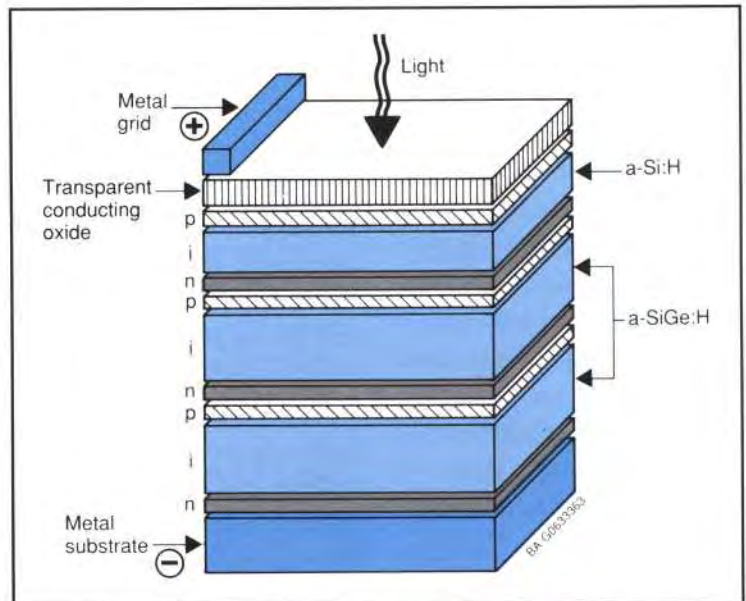

Typical structure of a triple-junction amorphous silicon device, which stacks three amorphous silicon cells with different band gaps.

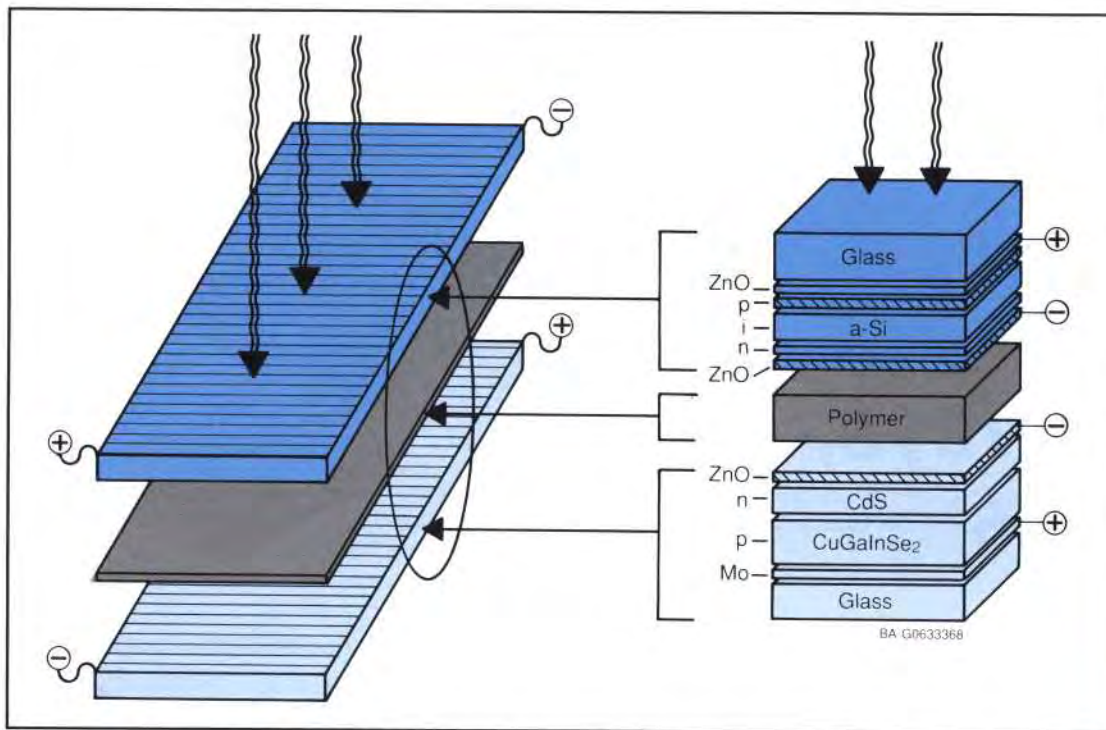

Structure of a multijunction device that employs an amorphous silicon submodule on top of a CIS submodule. The two submodules are laminated together with transparent polymer material. The CIS device uses gallium to make the band gap more suitable for use with the high-band-gap amorphous silicon.

material properties to improve multijunction devices. As of 1989, the most advanced triple-junction amorphous silicon cell had reached an efficiency greater than 13% in the laboratory.

Since the depositions needed to make thin-film multijunction devices do not use much energy, multijunction devices are potentially inexpensive to fabricate. Making a multilayered cell can be very similar to making one cell—just adding one thin film after another. In fact, the trend in amorphous silicon is away from single-junction and toward multijunction devices.

Copper Indium Diselenide

Copper indium diselenide cells have a band

gap of 1.0 eV. Viable by themselves, they can also be used with a higher-band-gap material in a multijunction device. One company is exploring the commercial possibilities of a multijunction device employing amorphous silicon (with a band gap of about 1.7 eV) on top of CIS. Laboratory multijunction devices have achieved 16% efficiency and submodules, 12% efficiency. A commercial multijunction module of CIS and amorphous silicon is expected to produce about 67 W of power, but it is likely to be more expensive than the combined cost of a panel of each individual thin film.

Copper indium diselenide is a versatile material being explored for use as a bottom cell in

tandem with top cells of other materials, such as CdTe and GaAs, both of which have band gaps of approximately 1.43 or 1.44 eV. In fact, recently an experimental multijunction device that used GaAs for the top cell and CIS for the bottom cell achieved an efficiency of 25.8%.

- The trend in a-Si is away from single-junction and toward multijunction devices.
- With a band gap of 1.0 eV, CIS cells make a good bottom cell in conjunction with an a-Si top cell.
- A-Si/CIS multijunction cells and modules have achieved efficiencies exceeding 16% and 12%, respectively.
- CIS is also a good choice as the bottom cell in conjunction with a top cell of either CdTe or GaAs.

Chapter 4

Modules, Arrays, and Systems

- A individual cell, the basic unit of a PV system, does not produce much power.
- To produce more power, cells are connected together into larger units to form modules, which can be connected together into larger units called arrays.
- We can refer to modules and arrays as collectors, and can categorize collectors into two types: flat plate and concentrator.

The PV cell is the basic unit in a PV system. An individual PV cell typically produces between 1 and 2 W, hardly enough power for the great majority of applications. But you can increase the power by connecting cells together to form larger units called *modules*. Modules, in turn, can be connected to form even larger units known as *arrays*, which can be

interconnected for more power, and so on. In this way, you can build a PV system to meet almost any power need, no matter how small or great.

Modules or arrays, by themselves, do not constitute a PV *system*. You must also have structures on which to put them and point them toward the sun, and components that take the direct-current (dc) electricity produced by the

modules or arrays and condition the electricity so that it may be utilized in the application. These structures and components are referred to as the balance-of-system (BOS).

In this chapter we discuss collectors (modules and arrays) and balance-of-systems, respectively. Further, we categorize the collectors into two general types: flat plate and concentrator.

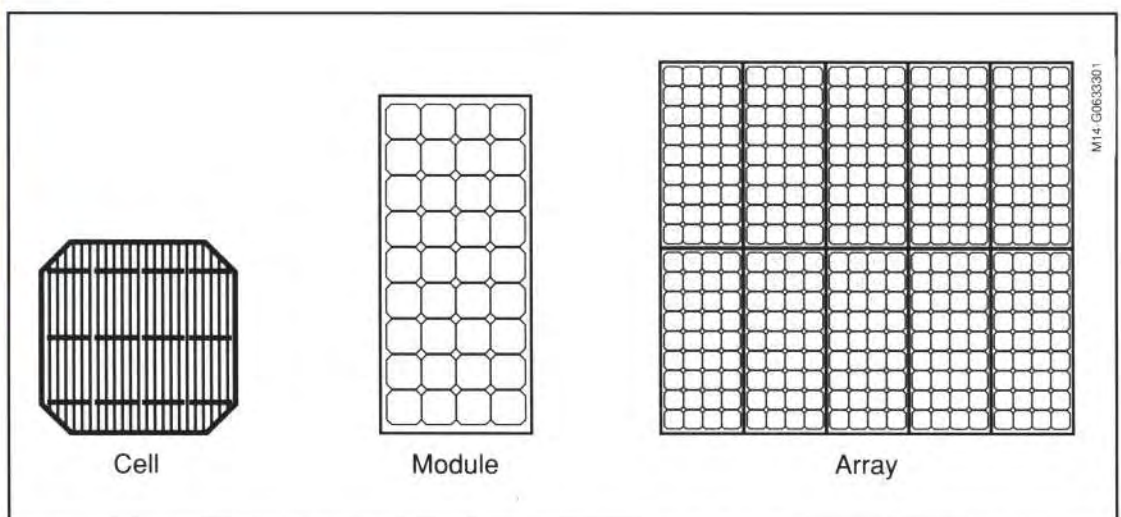

The basic photovoltaic unit or cell typically produces only a small amount of power. To produce more power, cells can be interconnected to form modules, which can be connected into arrays to produce more power, and so on. Because of this modularity, photovoltaic systems may be designed to meet any electrical requirement, no matter how large or how small.

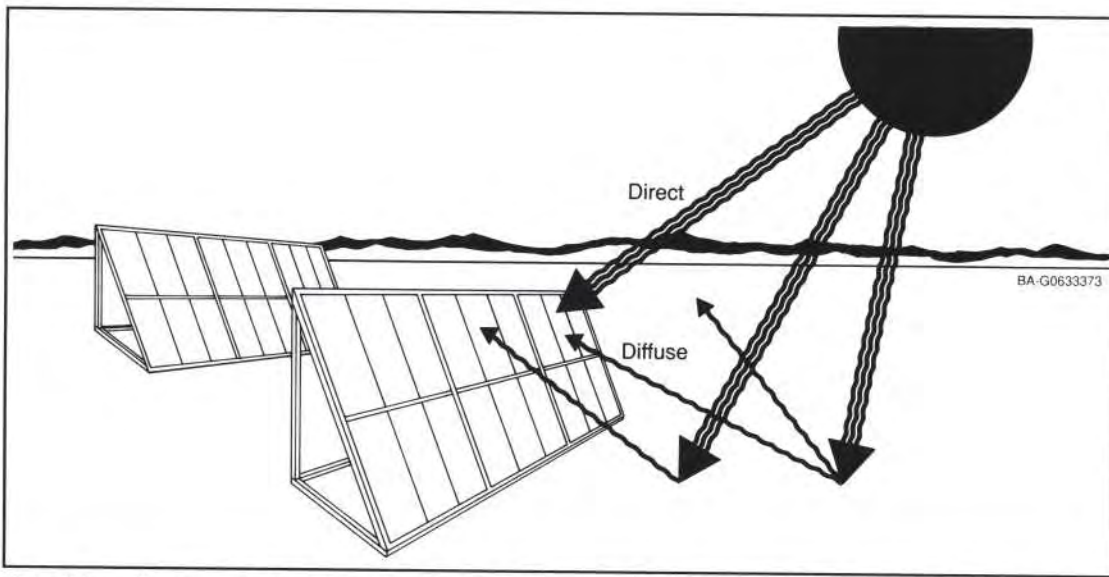

Flat-plate collectors, which typically employ large numbers of cells mounted on a rigid, flat surface, can use both direct sunlight and diffuse sunlight that is reflected from clouds, the ground, and nearby objects.

Flat-Plate Collectors

Flat-plate collectors typically use large numbers or areas of cells that are mounted on a rigid, flat surface. These cells are encapsulated with a transparent cover that lets in the sunlight and protects them from the environment.

Flat-plate collectors have several advantages in comparison to concentrator collectors. They are simpler to design and fabricate. They do not require special optics, specially designed cells, or mounting structures that must track the sun precisely. Plus, flat-plate collectors can use all the sunlight that strikes them — both the direct sunlight and the diffuse sunlight that is reflected from clouds, the ground, and nearby objects.

But they do have drawbacks, the most important

of which is that they must use a large number of cells and hence depend on large areas of PV material, to produce power comparable to that produced by much smaller concentrator collectors. Since PV cells are very costly components of a PV system, using large areas of cells could be an economic liability. Furthermore, for sizable applications, the large relative area of

flat-plate collectors entails more land use, which also becomes an economic consideration.

Connecting Crystalline Cells to Produce Modules

With crystalline cells, such as crystalline silicon, modules are made by connecting individual cells, either in series or in

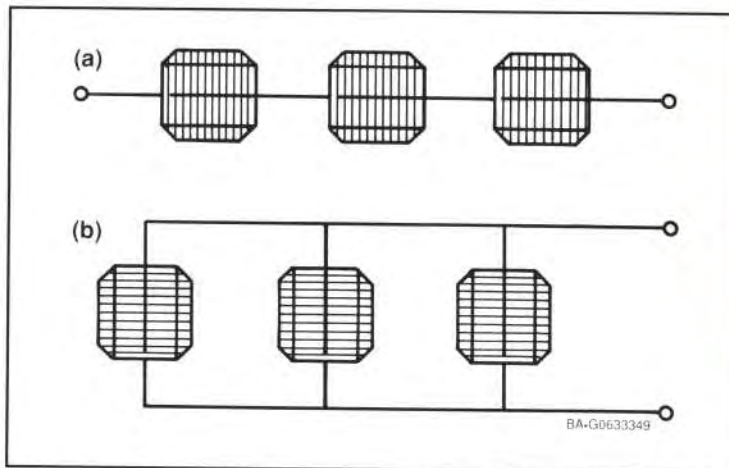

Joining cells in series (a) builds voltage while attaching them in parallel (b) increases amperage.

- A flat-plate collector contains a large number of cells that are mounted on a rigid, flat surface, and encapsulated with a transparent cover.
- Flat-plate collectors can use both direct sunlight and the diffuse sunlight that is reflected from the clouds, ground, and nearby objects.
- Flat-plate collectors do not require special optics, specially designed cells, or structures that must track the sun.

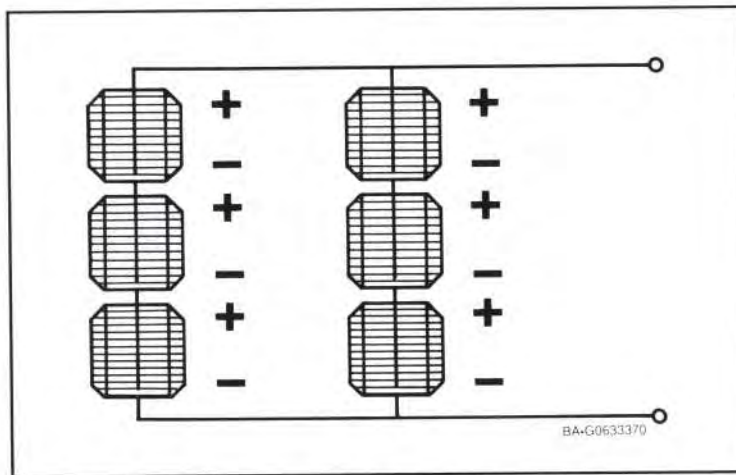

Both voltage and amperage are increased by arranging cells in both series and parallel.

- For crystalline cells, modules are made by connecting together individual cells.
- Connecting cells in series increases voltage and connecting them in parallel boosts current.
- The connections between cells must provide good conductivity and must withstand environmental stresses for extended periods.
- Thin-film modules are made by depositing layers of semiconductor material over the entire module area and then scribing in the separate cells with a laser.

parallel. Joining individual cells in series builds voltage without increasing amperage. Conversely, attaching cells together in parallel increases amperage without raising voltage. When both effects are needed, as in most electric power requirements, then the PV cells can be arranged in both configurations: first the cells are assembled in strings in series to build voltage; then the strings are grouped together in parallel to boost amperage.

The interconnections among individual cells within the module are extremely important. They have proved to be one of the most sensitive design elements in the system. These interconnections must provide good conductivity and reliability for expanded periods despite large variations in temperature and other environmental stresses that can harm the performance of PV systems.

One of the most delicate areas in modules is the attachment between the interconnecting wire and the PV cell terminal. This attachment is made by soldering or welding. Neither technique has proved superior to the other, and neither has proved to be entirely satisfactory at withstanding all environmental pressures. The method used to link cells to cells can be repeated when connecting modules to modules, though other procedures are available as well.

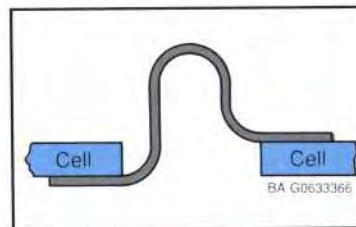

Interconnections between cells generally use a loop to prevent fatigue due to thermal and wind loading stresses.

Producing Thin-Film Modules

Unlike single-crystal and semicrystalline cells, thin-film cells can be fabricated in relatively large basic sizes. Though some efficiency is lost, scale-up is fairly easy, from an experimental cell (a few square centimeters in size) to a submodule (about 1000 square centimeters), to a commercial-sized module (about 4000 square centimeters). After the required layers are deposited over the entire surface of the module, a laser cuts in or scribes the lines that define the separate cells.

Unlike single-crystal modules, thin-film modules are not plagued by problems associated with interconnecting individual cells. Individual cells of any size and number are made by scoring the sequential layers (either with a laser beam or mechanically) as they are made so that the top

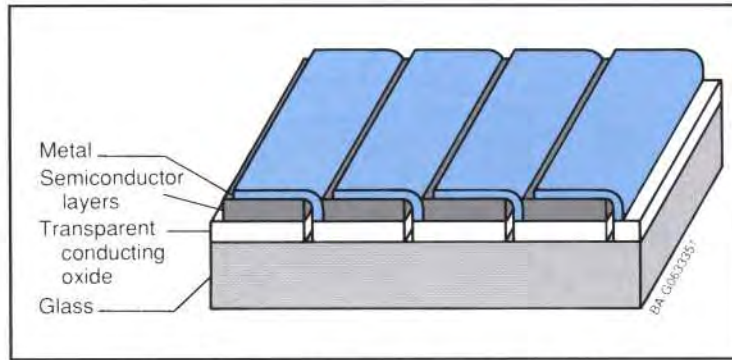

The individual cells of a thin-film module may be scribed in any size, number, or pattern. Scoring the sequential layers of the cells as they are made connects the top electrode of one cell to the bottom electrode of another cell, linking them in series. By adjusting scoring patterns, we can define the voltage of the module.



Thin-film modules are made differently than single-crystal modules are. Typically, the semiconductor layers are deposited over the entire surface of the module (or submodule, depending on the size desired for the basic unit), and then a laser cuts in or scribes lines that define the separate cells.

electrode of one cell connects with the bottom electrode of another cell, linking them in series. Since the voltages of cells in series add, the total voltage for a module can easily be adjusted by changing the scoring pattern that defines the number and size of individual cells.

Connecting Modules to Produce Arrays

Whether modules are composed of thin-film cells or crystalline cells, good interconnections between the modules are critical to good performance. Modules are typically attached to each other with metal wire or meshlike ribbons that are usually kept as short as possible. The interconnections between modules can be rigid or flexible, although flexible connections contend better with movement within the array caused by environmental forces such as thermal expansion.

Safety, Protection, and Support

One key area of concern for PV designers is safety. A fire hazard occurs, for example, when the electrical arcing between groups of electrically imbalanced cells causes sparks. This imbalance can be due to

partial shading of the module. But arcing can be prevented by properly insulating the area between modules. In addition, safety switches must be provided to isolate cells during repair work.

Individual crystalline solar cells are fragile. They must be protected from the elements and from the adverse effects of moving them around during assembly and maintenance. They must also have support, in various module arrangements, so they can be incorporated into an overall array design. Although thin-film modules are not as fragile, they too need to be protected and supported.

The design and construction of the module provide both the protection and the support required. A typical module design may incorporate a back structural layer of metal, epoxy board, or glass to provide rigidity; layers of laminate material, such as

- Whether thin film or crystalline, arrays are made by connecting individual modules.
- Modules are designed and built with covers and structural support that protect them from the environment and from adverse effects of moving them around.
- The typical module design incorporates a back or front structural support, laminates to encapsulate the cells, and a transparent glass or plastic cover.

- For terrestrial applications glass covers are preferred for their low cost, resistance to environmental conditions, and ability to retain clarity.
- For space applications, to cut down on weight, plastic is used to cover each cell (as opposed to covering the entire module.)

ethylene vinyl acetate or polyvinyl butyrate, to encapsulate the cell within the module; and a transparent cover made of glass or plastic. Although the cover and the cell encapsulant lend structural support to the module, their primary purpose is to protect the cells from wind, dust, temperature extremes, humidity, and oxygen seepage.

Module covers must be transparent to the portion of the sunlight spectrum that activates PV cells, so cover materials usually admit light in the violet to the far-infrared spectrum and beyond. Cover materials that have been used either separately or in combinations include glasses and both rigid and flexible plastics. For terrestrial applications, glass is usually preferred for its low cost, resistance to environmental conditions, and ability to retain its clarity. Clarity is especially

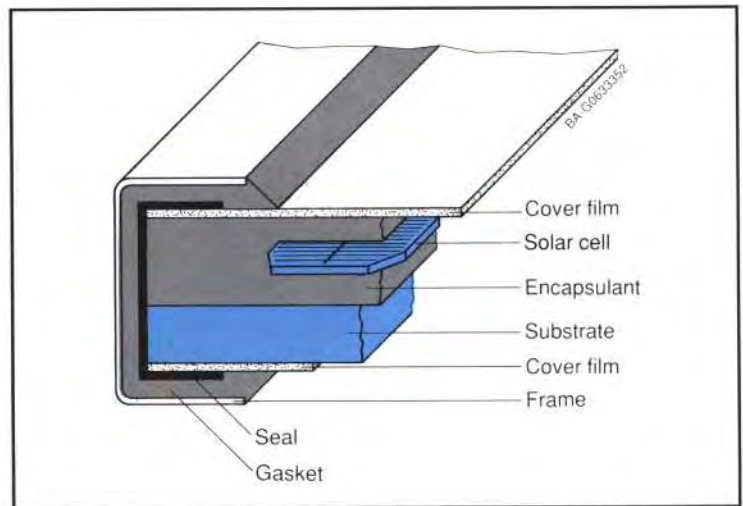

One typical module design uses a substrate of metal, glass, or plastic to provide back structural support; encapsulant material to protect the cells; and a transparent cover of plastic or glass.

important: if glass is washed regularly, its ability to transmit light (its transmissivity) will remain within 5% of what it was at the time that it was manufactured. Even the best plastics, however, will lose 25% or more of their transmissivity within several years after first being put to use.

For applications in space, the primary concerns are radiation damage and weight. Minimizing radiation damage depends primarily on the selection of the type and

quality of the semiconductor material used to make the cell. To cut down on weight, modules generally do not employ an integral cover. Rather, each cell is encapsulated individually, and plastic materials are often the first choice for the encapsulation material.

Module Design Considerations

For crystalline silicon modules, there are spatial considerations as well. Areas in a module where there are no PV cells do not produce electricity.

Square cells can be packed more densely than circular cells to produce more efficient modules.

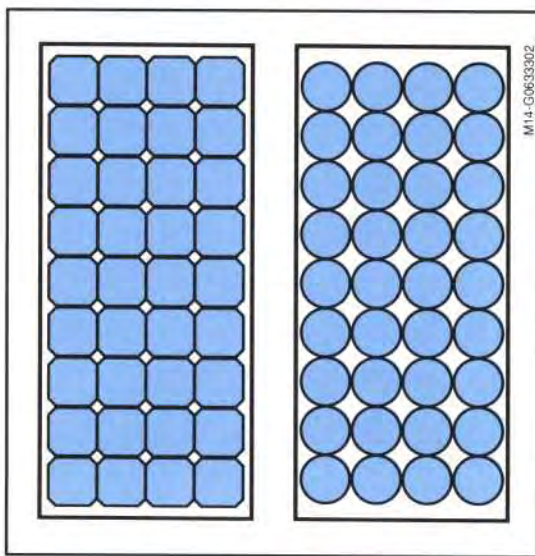

Thus, overall module efficiency, measured as wattage per unit area of the module, drops as the spaces between cells increase. This seemingly obvious cause-and-effect situation is important to PV system economics, because it can drive up the balance-of-system costs of a PV array (see pages 56 and 57). A less efficient module requires more land area to produce a given amount of electricity.

To increase the packing efficiency (i.e., the percentage of a module's area filled with active PV material that can produce electricity), most modules are packed with square cells. The most common process for making single-crystal cells, on the other hand, relies on the Cz technique, which produces a cylindrical ingot approximately 5 in. (12.7 cm) in diameter. The ingot is sliced into round wafers, which are subsequently trimmed to a square 4 in. (10.1 cm) on a side.

Semocrystalline square cells can be produced with casting technology. Casting produces a square block of semocrystalline silicon approximately 8 in. (20.3 cm) on a side. The block is sliced into wafers, each of which is then cut into four square wafers 4 in. (10.1 cm) on a side.

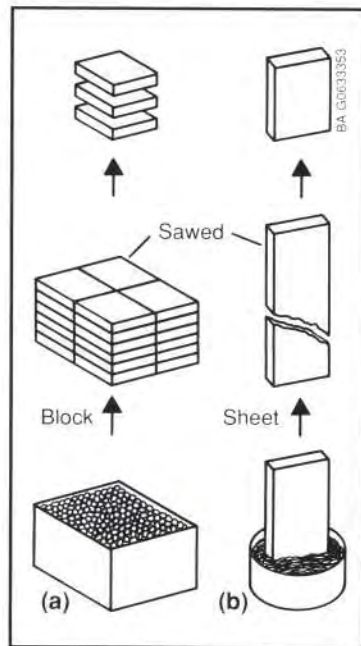

Two ways to make square cells for modules are casting (a), in which cubes are sliced and cut into square wafers, and ribbon-growth (b), in which thin, rectangular sheets of silicon are cut into wafers.

The silicon-ribbon growth techniques also result in square PV cells that require no sawing step. Though such methods have been researched extensively, their costs are still not competitive with ingot or casting techniques. Besides, cells made from ribbon material are smaller and often produce electricity less efficiently than cells cut from ingots or blocks.

Cell sizing is another important consideration in creating modules with the desired overall electrical characteristics. The current available from a cell grows with the size of the cell, because more sunlight lands on a larger cell, but the voltage remains constant. Thus, modules providing large voltage outputs require many small cells connected in series.

- Module efficiency, measured in wattage per unit area of module, drops as the spaces between cells increase.
- To increase efficiency, most modules are packed with square cells.
- One way to make square cells is by trimming Czochralski wafers, which are grown round, to a square shape.
- Two other ways are casting, in which cubes are cut and sliced into square wafers, and ribbon-growth, in which rectangular sheets of silicon are cut into wafers.

- Concentrator collectors use lenses to increase the intensity of sunlight striking the cells.
- The typical concentrator unit consists of a lens, a cell assembly, housing for the cell and lens, a secondary concentrator, and a mechanism to dissipate heat.
- The basic advantage of a concentrator is that it decreases the solar cell area; solar cells are the most expensive components of a PV system.

Concentrator Collectors

The performance of a PV array can be improved in a number of ways. One option is to employ concentrating optics, which gather sunlight with lenses, thereby increasing the intensity of sunlight striking the PV cell. A typical basic concentrator unit consists of a lens to focus the light, a cell assembly, a mechanism that houses the lens at one end and the cell at the other, a secondary concentrator to reflect off-center light rays onto the cell, a mechanism to dissipate excess heat produced by concentrated sunlight, and various contacts and adhesives. The cell may also use a prismatic cover to guide the light around the cell's metallic grid and onto the active cell material. These basic units may be combined in any configuration to produce the desired module.

The primary reason for using concentration is to decrease the area of solar cell material being used in a system; solar cells are the most expensive components of a PV system, on a per-area basis. A concentrator uses relatively

inexpensive materials (plastic lenses, metal housings, etc.) to capture a large area of solar energy and focus it onto a small area, where the solar cell resides. One measure of the effectiveness of this approach is the

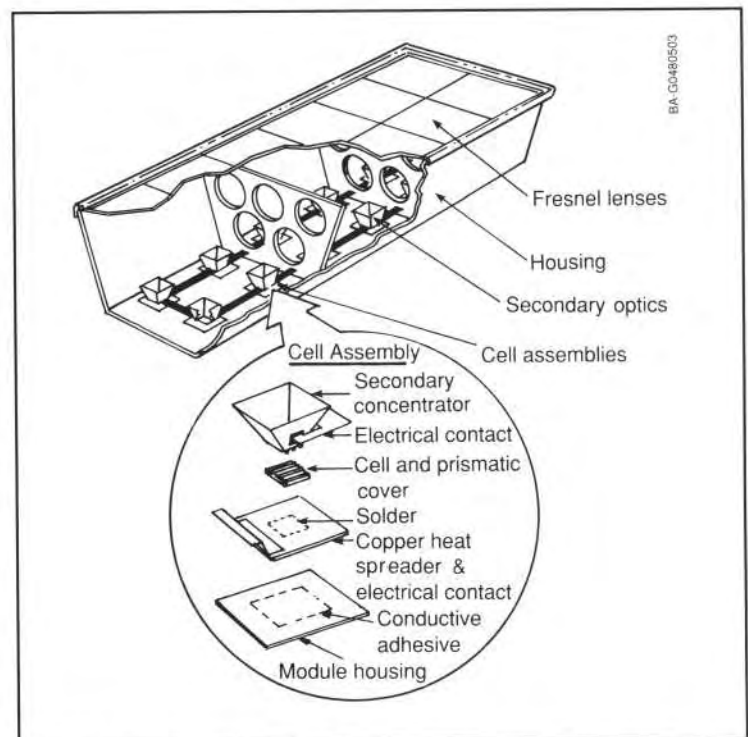

A typical basic concentrator unit consists of a lens to focus the light, a cell assembly, a housing element, a secondary concentrator to reflect off-center light rays onto the cell, a mechanism to dissipate excess heat produced by concentrated sunlight, and various contacts and adhesives. Notice that the module depicted uses 12 cell units in a 2x6 matrix.

The concentration ratio, the power at which the sun is concentrated, is equal to the area of the aperture (the opening through which the sunlight enters — in this case, the aperture is a lens) divided by the area of the illuminated cell.

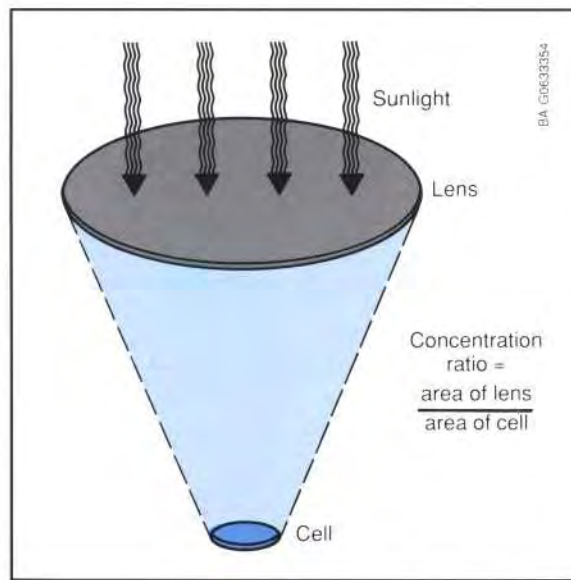

concentration ratio. Ideally, the concentration ratio is the area of the lens divided by the area of the cell. (We say “ideally” because there are reflection and absorption losses.) Thus, if we have a lens with an area of 200 cm² focusing light on a cell that has an area of 4 cm², the concentration ratio is 50. With this ratio the cell receives 50 times the amount of sunlight it would get under unconcentrated sunlight, which means you can cut the cell area by 50 times (relative to flat-plate collectors) to get a desired amount of power.

Besides increasing the power and reducing the size or number of cells used, concentrators have the additional advantage that cell efficiency increases under concentrated light, up to a point. How much the efficiency increases depends largely on the cell design and the cell material used. Another advantage of

concentrators is that they can use small individual cells — an advantage because it is harder to produce large-area, high-efficiency cells than it is to produce smaller-area cells.

There are, on the other hand, several drawbacks to using concentrators. The concentrating optics they require, for example, are significantly more expensive than the simple

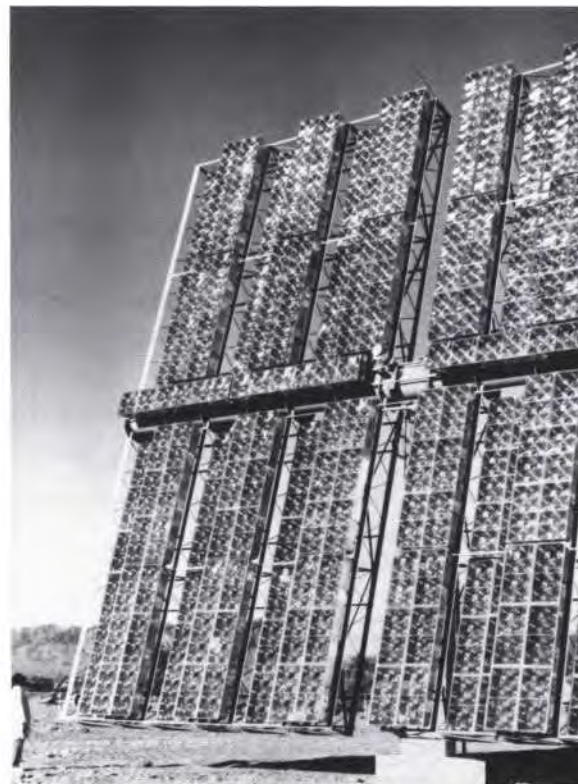

Concentrating systems, especially those with high concentration, require mechanisms that track the sun. This particular system has a reinforced concrete pedestal as a base, a sun sensor (in the middle of the system), and a drive mechanism that allows the array to track the sun east to west during the day and north and south through the seasons.

- Generally speaking, the greater the concentration, the greater the power, and the less the amount of cell area needed.
- Besides increasing power and reducing cell area, concentrators have the additional advantage of increasing cell efficiency, up to a point.

- Most concentrator systems must use expensive mechanisms to track the sun along two axes.
- Concentrators cannot focus diffuse sunlight; they can only use direct sunlight.
- Some direct sunlight is lost as well, because an inherent limitation to a concentrator is that some of the sunlight fails to strike effective areas of the lenses.
- Because of high temperatures generated, concentrators must incorporate designs or mechanisms that keep the cells cool.

covers needed for flat-plate modules. Also, most concentrators (those with concentration ratios greater than 10, i.e., those that make the effective sunlight energy striking the cell 10 times greater than that of ordinary sunlight) must track the sun along two axes to be effective. This is because the field of view—the angular window where light must fall to be acted on by the concentrating optics—generally gets smaller as the concentration ratio increases. Thus, higher concentration ratios mean using not only expensive

tracking mechanisms but also more precise controls than flat-plate systems with stationary structures.

Another inherent disadvantage of concentrators compared with flat-plate modules is that they can use only direct sunlight. Concentrators cannot focus diffuse sunlight, which represents about 20% of the sunlight received in a desert region. As a result, concentrators produce little output on cloudy days and are intended for use chiefly in areas with very few such days.

Besides diffuse sunlight, some direct sunlight is

lost as well, because an inherent limitation of any concentrator is that a portion of the sunlight fails to strike effective areas of the lenses. A line-focus concentrator (one that focuses sunlight along a line) can lose as much as 10% of incident direct sunlight, and a point-focus concentrator (one that focuses sunlight at a point) can lose from 10% to 20%.

High concentration ratios are a particular problem, because the operating temperature of cells increases when excess radiation is concentrated, creating heat. Cell efficiencies decrease as temperatures increase, and higher temperatures also threaten the long-term stability of PV cells (as well as most semiconductor devices). Therefore, PV cells must be kept cool, either by passive cooling (such as metal fins to radiate heat) or by active cooling, such as circulating coolants.

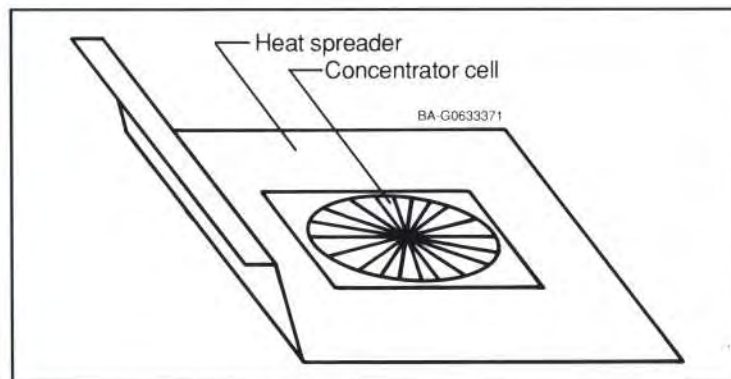

Concentration can create heat, which can be deleterious to cell efficiency and operation. One way to keep cells cool is to mount the cells on a heat spreader, which spreads the heat and radiates it away from the cell.

Concentrating Optics

As of the late 1980s, the most promising lens for PV concentrating optics applications was the Fresnel lens, which features a miniature sawtooth design. When the “teeth” run in straight rows, the lenses act as line-focusing concentrators; when the teeth are arranged in concentric circles, light is focused at a central point. The combination of Fresnel lenses, high-efficiency silicon PV cells, and two-axis tracking is currently considered to be the most promising concentrating approach.

Special Types of PV Cells

The development of PV cells for concentrators has been evolving in three major directions. Low-concentration systems (with a concentration of 10 to 50 times), for expediency and near-term use, generally employ PV

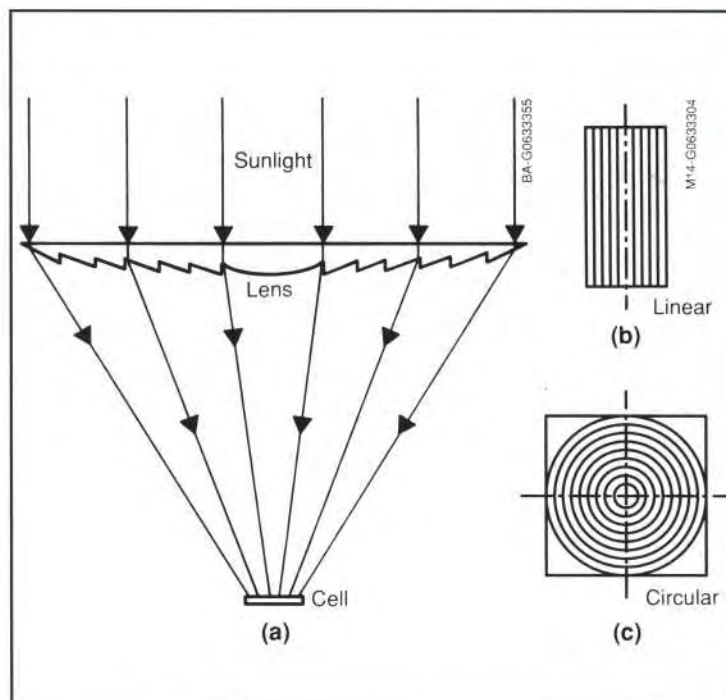

A Fresnel lens, the most common lens in concentrator systems, is a sheet of plastic that is flat on the upper side and that has sawtooth grooves on the bottom (a). If the grooves are etched in parallel ridges (b), they concentrate light along a line. If they are etched in concentric circles (c), they concentrate light at a point.

cells developed for one-sun applications with no modifications. Mid-concentration systems (with a concentration of 50 to 300 times) include most of the high-efficiency PV cells being developed today. As to high-concentration systems (with concentrations

greater than 300 times), the expense of manufacturing PV cells with such high-efficiency performance may make the entire system too costly.

At mid-concentration ranges, concentrating modules require some changes in cell features for the best performance. As

- The Fresnel lens, a lens that uses a miniature sawtooth arrangement, can be designed to focus light at a point or along a line.
- Systems with concentration ratios between 10 and 50 generally use cells that are developed for one-sun applications.
- Systems that concentrate the sun from 50 to over 300 times use specially designed, high-efficiency cells.

- Usually, cells designed for concentration are thinner than normal cells, have a lower cell resistance, and have special grid patterns.
- The specially designed point-contact cell, incorporates a textured top, a reflective back surface, silicon dioxide layers at the front and back surfaces, and thousands of small contacts on the back surface to collect charge carriers.

the intensity of the incident light increases, so does the short-circuit current of the PV circuit. With a higher current, series resistance losses become important. Several resistance-lowering features can be incorporated into high-efficiency cells, and they are particularly important for cells that will be used under high concentration ratios.

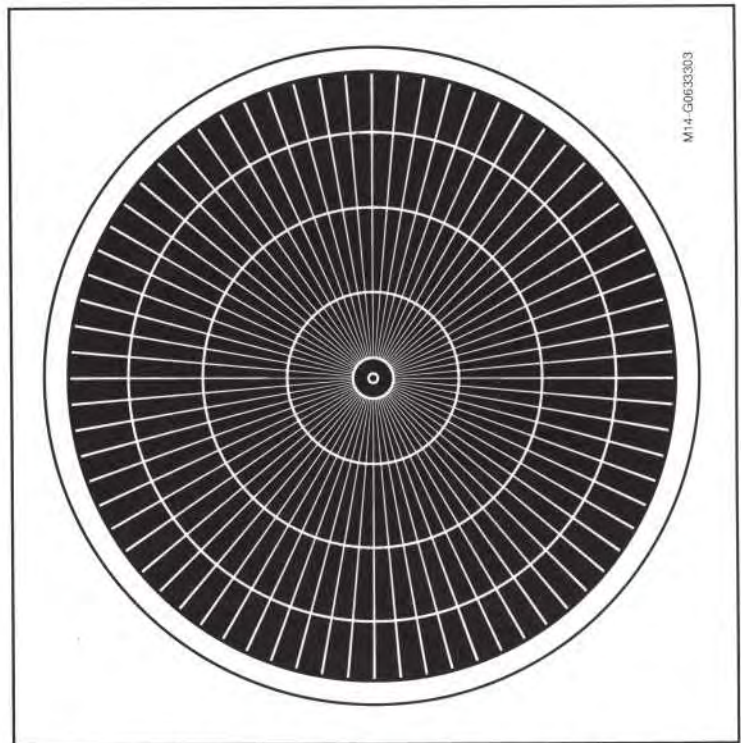

M14-G06C33003

Cells designed for concentrators usually have special grid patterns. This cell could handle concentrations up to 200 suns. (Depiction based on a cell used by Applied Solar Energy Corporation.)

Usually, cells designed for concentration are thinner than normal cells, have a lower cell resistance, and have special grid patterns devised to carry the high

currents without blocking much of the cell's surface area.

Point-contact PV cells, which are fashioned for use with concentrators, are the most efficient silicon solar cells reported to date and have achieved efficiencies above 28% under concentration. These cells are uniquely designed to capture the maximum amount of light and to generate the greatest amount of current. A conventional solar cell has an electrical grid on the front and a solid electrical contact on the back. Each point-contact cell, in contrast, has tens of thousands of microscopic points of alternating positive and negative contacts that occupy only about 5% of the cell's back surface.

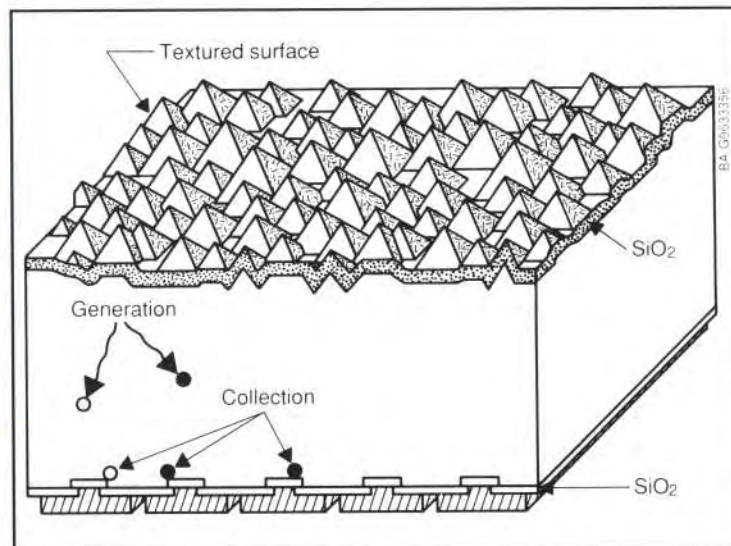

The point contact cell, designed by Swanson et al. at Stanford University, is a concentrator cell that incorporates several innovations, including a textured top, a reflective back surface, silicon dioxide layers at the front and back surface, and thousands of small contacts on the back surface to collect charge carriers. (Adapted from the *Proceedings of the 18th IEEE Photovoltaic Specialists Conference* with permission from IEEE.)

The microgrooved cell designed by Green et al. at the University of South Wales uses very high quality silicon with a thin layer of silicon dioxide on the top surface. Thin grooves are cut into the oxide, over which are laid very thin fingers of a metal grid. (Adapted from the *Proceedings of the 19th IEEE Photovoltaic Specialists Conference* with permission from IEEE.)

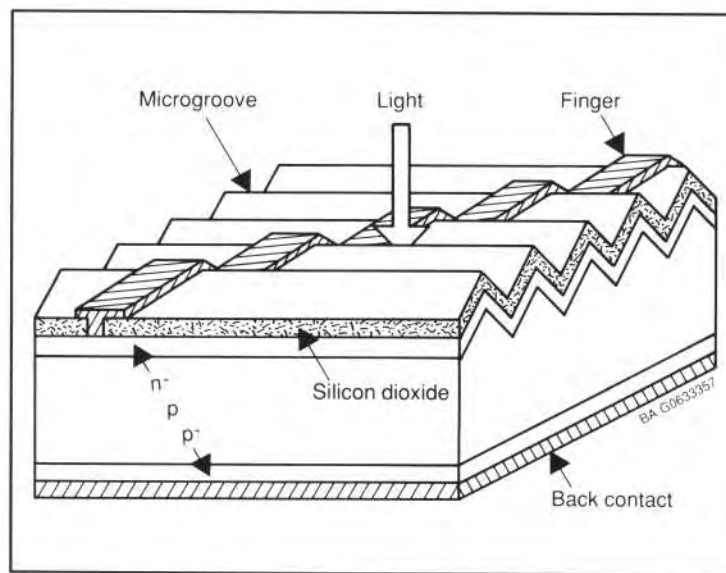

Putting the point contacts on the back removes any shading or recombination that might otherwise have occurred by putting them on the front surface. Making them small significantly reduces the contact surface area, which decreases recombination and contact resistance. And implanting so many contacts enhances efficient collection of light-generated charge carriers.

The front surface of the cell is textured with small pyramid shapes; this reduces the reflection of incident sunlight and scatters the light into the cell at angles that allow the light to be trapped inside the cell (reflecting back and forth without escaping) until the light is absorbed. To maximize this "light trapping," the back surface is highly reflective and reflects the great majority of the unabsorbed photons back into the interior of the cell. With these two features the cell can be made very

thin (100 microns or less) and still absorb nearly all of the usable light. The high percentage of light absorption produces a large number of charge carriers, and the thinness of the cell helps the carriers reach the terminals for collection before they can recombine. To help reduce surface recombination, the cell also employs thin layers of silicon oxide at the front and back surfaces.

Finally, the cell uses an antireflection coating on the front surface to decrease reflection losses.

Microgrooved passivated emitter solar cells have a more conventional structure than point-contact cells. The base material is very high quality silicon; a thin layer of silicon dioxide is applied to the surface to inhibit recombination.

Several special features enhance the efficiency of this device. Thin slots or grooves in the oxide allow contact between the metal grid and the emitter. The

grooves also help to minimize reflection and to trap light inside the cell. The thin metal grid, laid across the grooves at a 45° angle, allows some of the light to be reflected from the metal fingers and to enter a non-metallized region.

To further enhance efficiency, these cells are also being used with prismatic covers, which help overcome shadowing losses due to top contacts. These special cell covers are etched in such a way that they direct incoming sunlight away from areas of the PV cell covered by metal grid lines. Prismatic covers have been shown in the laboratory to improve efficiency by 20% (relative), and they are beginning to appear in commercial projects.

High-efficiency multijunction PV cells, of which there are many designs, are particularly suited for use under concentrated sunlight. One reason for this is because of the wide selection of material com-

- Back contacts on the point contact cell reduce shading and recombination.
- Texturing reduces reflection and, along with the reflective back surface, traps light inside of the cell.
- The microgroove cell uses high-quality silicon, a thin layer of silicon dioxide on the top surface, and thin grooves cut into the silicon dioxide overlaid with a metal grid.
- The microgroove cell also uses a prismatic cover, which directs incoming sunlight away from grid lines and helps overcome shadowing losses.

- A complete PV system consists of three subsystems: the array, the load, and the balance-of-system (BOS).
- The BOS consists of such things as mounting structures, storage devices, and power conditioners.
- Mounting structures, which support PV arrays and are built to withstand wind, rain, hail, and other conditions, come in two types: stationary and tracking.
- Stationary structures, used with flat-plate systems, tilt the array at a fixed angle that is largely determined by the latitude of the site.

binations available; you can choose materials that perform well under stressful conditions (heat, in particular) induced by concentrated sunlight. Another reason is that multijunction devices, which can be designed to reach efficiencies of 30% or more under normal sunlight, can reach even higher efficiencies under concentration. (Multijunction devices are discussed more fully in Chapter 3.)

Balance of Systems

We may think of a complete PV system as comprising three subsystems. On one side, we have the PV devices (modules, arrays, etc.) that convert sunlight into dc electricity. On the other side, we have the load, the application for which the PV electricity is intended. In between, we have a third subsystem, a set of devices and structures that enables the PV electricity to be

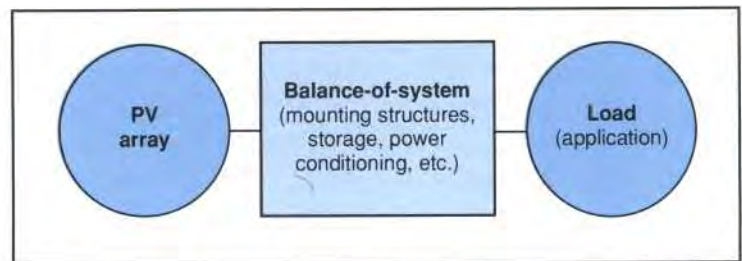

The complete PV system consists of three subsystems: the PV array, the load, and the balance-of-system (BOS). The BOS consists of devices and structures that enable the PV electricity to be properly applied to the load. Among these are mounting structures, storage devices, and power conditioners.

properly applied to the load. This third subsystem is generally referred to as the “balance-of-system,” or the BOS.

The BOS typically contains structures for mounting the PV arrays or modules and the power-conditioning equipment that massages and converts the dc electricity to the proper form and magnitude required by an alternating-current (ac) load. If required, the BOS also includes storage devices, such as batteries, for storing PV-generated electricity during cloudy days and at night.

Mounting Structures

Photovoltaic arrays have to be mounted on some sort of stable, durable structure that can support the array and withstand wind, rain, hail, and other adverse conditions. The mounting structure can either be stationary or it can track the sun.

Stationary structures, used with flat-plate systems, generally tilt the PV array at a fixed angle that is determined by the latitude of the site, the requirements of the load, and the availability of the sunshine. Stationary structures may be mounted

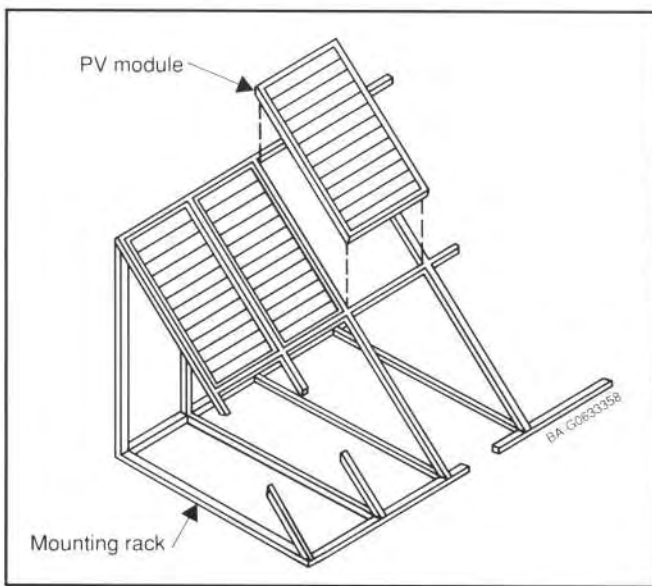

Among the choices for stationary mounting structures, rack mounting may be the most versatile. It requires relatively simple construction techniques and hardware and can be installed easily on the ground or on flat or slanted roofs.

either on the ground or on a building. Where space is at a premium, such as for a business or an urban residence, roof mounting is generally the preferred option. But mounting a system on a roof may require interfering with the integrity of the roof or special designs that integrate the PV system with the roof, tilt the system (and roof) at the proper angle, and allow access for operation and maintenance. For more remote, stand-alone systems, on the other hand, ground mounting is generally preferable because it allows for greater ease of installation, maintenance, and operation.

There are several options for stationary mounting structures, among which are pole, rack, integral, standoff, and direct mounting (the last three are roof mounts only). Among these, rack mount-

ing may offer the most flexibility, since it may be used either on the ground or on roofs and can be easily designed and built to accommodate the requirements of the application.

For tracking structures, there are two general kinds: one-axis and two-axis. The two-axis type,

which we have already described above, is primarily used for PV concentrator systems that have a moderate to high concentration ratio. Single-axis trackers, which are typically designed to track the sun from east to west on its daily route, are used with flat-plate systems

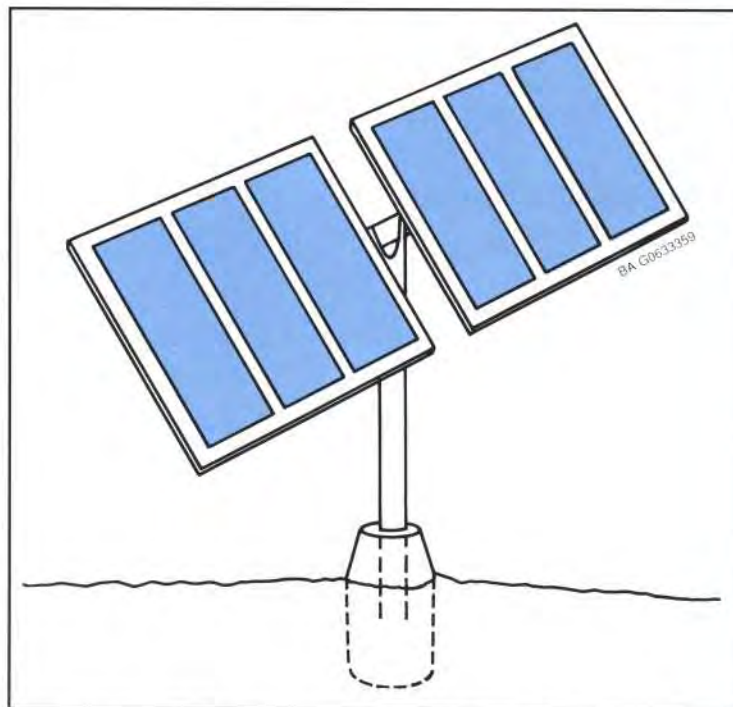

A pole-mounted, single-axis tracker may be used with flat-plate systems or with concentrator systems that have low concentration ratios. These mounting structures often rely on passive tracking, which requires no control or power, to follow the sun on its daily east-to-west course.

- Stationary structures can be mounted either on the ground or on a building.
- Of the options for stationary mounting structures (pole, rack, integral, standoff, and direct), rack mounting may offer the most flexibility.
- There are two general kinds of tracking structures: one-axis and two-axis.
- One-axis structures track the sun east to west.
- Two-axis structures track the sun east to west and north to south.

- One way to store PV electric power is to hook the PV system into a utility grid, which can provide power when the PV system is not generating enough electricity.
- For stand-alone systems, however, batteries are the most common storage option.
- Batteries increase the cost of a PV system, decrease system efficiency, pose safety concerns, and require periodic maintenance.
- But, batteries store electricity and can serve as a power conditioner by keeping the electrical load nearly constant.

and with concentrator systems that have low concentration ratios. Tracking structures are almost always mounted on the ground.

Storage Devices

One way to store PV electric power is by hooking the PV system into a utility grid. When more PV electricity is being generated than is being used, it can be converted to alternating current, the same frequency as that of the utility grid, and fed into the grid. Likewise, when the PV system is not providing enough electricity, the extra amount needed can be obtained from the grid. This strategy is generally used by large systems and by residential systems when a convenient backup system is desirable.

In stand-alone systems, however, using the utility as a storage medium may not be desirable or even possible. In such cases,

batteries are the most common alternative.

But batteries have some drawbacks. For example, they decrease the efficiency of the PV system, since only 80% or so of the energy channeled into them can be reclaimed. They also add to the expense of the PV system and last only between five and ten years. They take up considerable floor space, pose some safety concerns, and require

periodic maintenance. Like PV cells, batteries are direct-current devices and are directly compatible only with dc loads.

On the plus side, batteries not only store electrical energy, they can also serve as a power conditioner. By being part of the circuit into which electricity from the PV supply flows, the battery keeps the electrical load more nearly constant, and the PV array can be



These Laguna Del Mar townhomes use PV to supply part of their electricity. They also use the local utility as a backup to store any extra power they may produce. An extra meter on each home monitors the electricity fed back to the utility company.

designed to operate closer to its optimum power output.

Today, there are several types of batteries specifically designed for PV systems; the most common are lead-acid batteries and nickel-cadmium batteries. Although nickel-cadmium batteries cost more than their lead-acid counterparts, they generally last longer, require less

maintenance, and can stand up under more extreme conditions.

Most batteries must be protected from overcharge and excessive discharge, which can cause electrolyte loss and can even damage or ruin the battery plates. Protection is most often afforded by a charge controller, which also maintains system voltage. Most charge controllers

also have a mechanism that prevents current from flowing from the battery to the array at night. One solid-state mechanism that does this is a blocking diode, which restricts the flow of electricity to one direction, blocking the electricity from going into the array and thus protecting the array from damage and saving energy.

Power Conditioners

Power conditioners process the electricity produced by a PV system to make it suitable for meeting the specific demands of the load. Although most of this equipment is standard stock, it is extremely important to match the capabilities of these devices with the characteristics of the load. Power conditioners may have to

- limit current and voltage to maximize power output,

- Several types of batteries are specifically designed for PV systems, the most common being lead-acid batteries and nickel-cadmium batteries.
- Power conditioners process PV electricity to make it suitable to meet the specific demands of the load.



For stand-alone systems, batteries are the most common alternative to store PV power for later use. These are batteries specially designed for photovoltaic applications; they are more durable than their automobile counterparts and can withstand deeper discharges. The type, size, and number of batteries used depends on the application.

- A power conditioner may have to maximize power output, convert dc to ac, match the ac electricity to a utility's network, and safeguard the utility network and its personnel from possible harm.

- convert dc power to ac power,
- match the converted ac electricity to a utility's ac electrical network, and
- safeguard the utility network system and its personnel from possible harm during repairs.

The requirements of power conditioners generally depend on the type of system they are integrated with and the applications of that system. For dc applications, power conditioning is often accomplished with regulators, which control output at some constant level of voltage and current to maximize output. For ac loads, power conditioning must include an inverter that converts the direct current generated by the PV array into alternating current. Essentially, an inverter is a set of automatic switches that provide polarity reversals from the solar array. The shape of the output waveform is determined

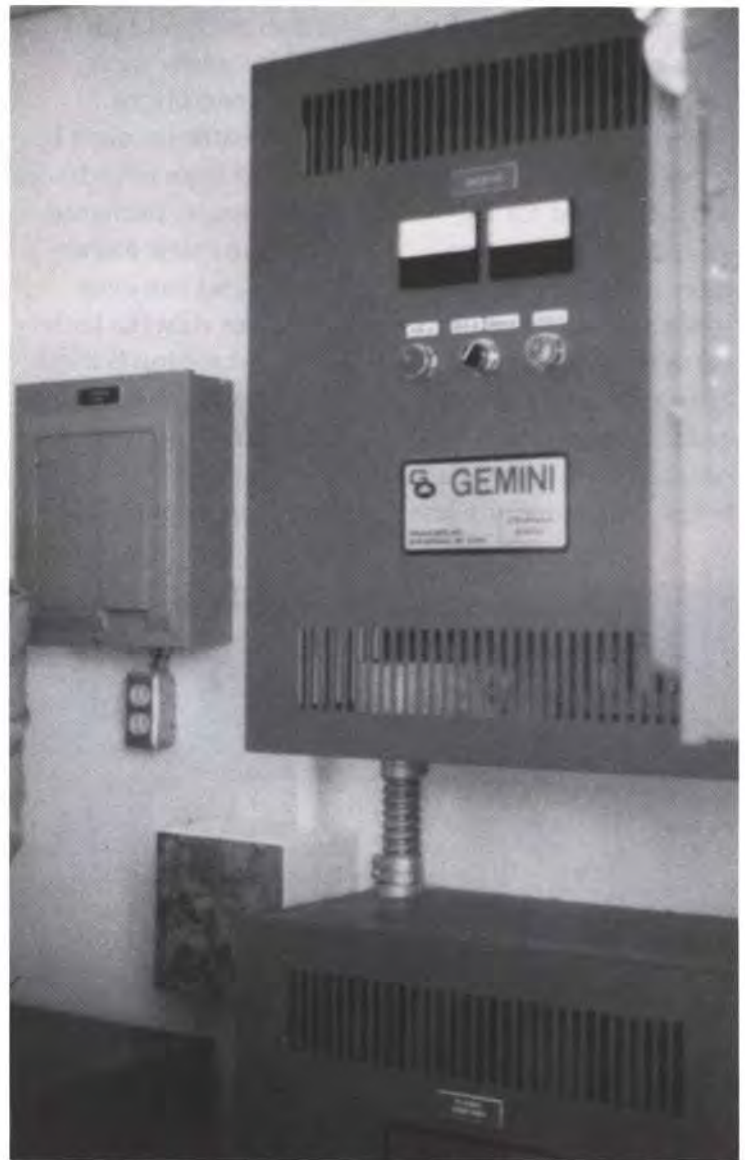

Power conditioners are used in many systems to maximize power output, change the dc electricity from the PV array to ac electricity, match the converted ac electricity to a utility's ac electrical network, and to protect the utility network system and its personnel from harm during repairs.

by the quality and cost of the inverter.

Other Devices

Most other power-related equipment is placed in a PV system because the system is hooked to a utility grid. In such cases, it is important that meters record the quantities of electricity being sold to and purchased from the utility. Other items of PV system

equipment that utilities may require are automatic lock-out switches or isolation transformers. These devices ensure that the PV and utility-grid systems will separate if there is a grid failure. If a PV system were allowed to send electricity into a utility grid that is shut down, this would create a safety hazard for utility workers.

- A PV system hooked to a utility network may also need meters, lock-out switches, and isolation transformers.

For Further Reading

This booklet introduces you to photovoltaic technology. It is not meant to be a complete and exhaustive resource. However, if this booklet spurs your interest, there are many publications that will broaden your knowledge of the field. Some of these delve into the theory of photovoltaics, the materials that make up PV devices, and designs of devices and systems. Others are more practical, describing applications and giving guidelines on how to design and install PV systems for your own use. We list just a few of the major sources below. For more technical information, you may contact DOE's Office of Scientific

and Technical Information, P.O. Box 62, Oak Ridge, TN 37831, or the Department of Commerce's National Technical Information Service, 5285 Port Royal Rd., Springfield, VA 22161.

- Fan, J.C.C. (1982). "Photovoltaic Cells." *Kirk-Othmer Encyclopedia of Chemical Technology*. Third Edition. New York: John Wiley and Sons, Inc.; Vol. 17, pp. 709-732.

This chapter provides a semitechnical overview of the theory and design of photovoltaic cells. It presents information on the chemistry of the photovoltaic effect, PV cells, and factors affecting the efficiency of various types of solar cells.

- Green, M.A. (1986). *Solar Cells: Operating Principles, Technology and Systems Applications*. Kensington, New South Wales, Australia: University of New South Wales; 274 pp.

Clearly written and well illustrated, this text covers many aspects of photovoltaics but is particularly strong in cell theory and cell designs. The mathematics and physics included here require a college background in these subjects.

- Komp, R.J. (1984). *Practical Photovoltaics: Electricity from Solar Cells*. Ann Arbor, MI: aatec Publications; 216 pp.

This is a general introduction to photovoltaics,

written on a level that an educated, nonscientific reader can understand. It also explains how solar cells work and are made; covers modules, arrays, applications, and how to size systems; and discusses new developments and the future of photovoltaics.

- *Stand-Alone Photovoltaic Systems: A Handbook of Recommended Design Practices*. (1988). SAND87-7023. Albuquerque, NM: Sandia National Laboratories; 414 pp. Available from the National Technical Information Service, U.S. Department of Commerce, 5285 Port Royal Road, Springfield, VA 22161.

This comprehensive guide recommends design

practices for stand-alone PV systems, including system-level trade-offs necessary for any application. Instructions and worksheets are included for system sizing, and 15 specific examples of PV systems in a wide range of applications are presented. The guide is intended for a broad audience, from beginners to PV professionals.

- Strong, S.J. (1986). *The Solar Electric House: A Design Manual for Home-Scale Photovoltaic Power Systems*. Emmaus, PA: Rodale Press; 288 pp.

A comprehensive design manual for both stand-alone and grid-connected systems, this book provides information for people with a variety

of backgrounds, from the novice to the experienced design engineer.

- Zweibel, K. (1990). *Harnessing Solar Power, The Photovoltaics Challenge*, New York: Plenum Press; 319 pp.

This well-written book gives the reader more than just an introduction to PV technology. It also delves into PV costs and trends of the technology and into politics and policy issues surrounding energy and PV.

Produced for the
U.S. Department of Energy



1000 Independence Avenue, SW
Washington, DC 20585

by the
National Renewable Energy Laboratory,
a DOE national laboratory

DOE/CH10093-117-Rev. 1
DE91015001
Revised February 1995

NOTICE: This report was prepared as an account of work sponsored by an agency of the United States government. Neither the United States government nor any agency thereof, nor any of their employees, makes any warranty, express or implied, or assumes any legal liability or responsibility for the accuracy, completeness, or usefulness of any information, apparatus, product, or process disclosed, or represents that its use would not infringe privately owned rights. Reference herein to any specific commercial product, process, or service by trade name, trademark, manufacturer, or otherwise does not necessarily constitute or imply its endorsement, recommendation, or favoring by the United States government or any agency thereof. The views and opinions of authors expressed herein do not necessarily state or reflect those of the United States government or any agency thereof.

Printed in the United States of America

Available to DOE and DOE contractors from:
Office of Scientific and Technical Information (OSTI)
P.O. Box 62
Oak Ridge, TN 37831

Prices available by calling (615) 576-8401

Available from:
National Technical Information Service
U.S. Department of Commerce
5285 Port Royal Road
Springfield, VA 22161
(703) 487-4650

Information pertaining to the pricing codes can be found in the current issue of the following publications which are generally available in most libraries: *Government Reports Announcements and Index (GRA and I)*; *Scientific and Technical Abstract Reports (STAR)*; and publication NTIS-PR-360 available from NTIS at the above address.



Printed with renewable-source ink on paper containing at least
50% wastepaper, including 20% postconsumer waste